

ioLogik E1200 Series User's Manual

Fifth Edition, February 2011

www.moxa.com/product



© 2011 Moxa Inc. All rights reserved.
Reproduction without permission is prohibited.

ioLogik E1200 Series User's Manual

The software described in this manual is furnished under a license agreement and may be used only in accordance with the terms of that agreement.

Copyright Notice

Copyright ©2011 Moxa Inc.

All rights reserved.

Reproduction without permission is prohibited.

Trademarks

The MOXA logo is a registered trademark of Moxa Inc.

All other trademarks or registered marks in this manual belong to their respective manufacturers.

Disclaimer

Information in this document is subject to change without notice and does not represent a commitment on the part of Moxa.

Moxa provides this document as is, without warranty of any kind, either expressed or implied, including, but not limited to, its particular purpose. Moxa reserves the right to make improvements and/or changes to this manual, or to the products and/or the programs described in this manual, at any time.

Information provided in this manual is intended to be accurate and reliable. However, Moxa assumes no responsibility for its use, or for any infringements on the rights of third parties that may result from its use.

This product might include unintentional technical or typographical errors. Changes are periodically made to the information herein to correct such errors, and these changes are incorporated into new editions of the publication.

Technical Support Contact Information

www.moxa.com/support

Moxa Americas

Toll-free: 1-888-669-2872

Tel: +1-714-528-6777

Fax: +1-714-528-6778

Moxa Europe

Tel: +49-89-3 70 03 99-0

Fax: +49-89-3 70 03 99-99

Moxa China (Shanghai office)

Toll-free: 800-820-5036

Tel: +86-21-5258-9955

Fax: +86-21-5258-5505

Moxa Asia-Pacific

Tel: +886-2-8919-1230

Fax: +886-2-8919-1231

Table of Contents

1. Introduction	1-1
Product Model Information	1-2
Product Features	1-2
Inside the Box	1-2
Product Specifications	1-3
Physical Dimensions	1-7
Hardware Reference	1-8
Panel Guide	1-8
LED Indicators	1-8
2. Initial Setup	2-1
Hardware Installation	2-2
Connecting the Power	2-2
Grounding the ioLogik E1200	2-2
Connecting to the Network	2-2
Jumper Settings	2-3
I/O Wiring Diagrams	2-3
Software Installation	2-5
Load Factory Default	2-5
3. Using the Web Console	3-1
Introduction to the Web Console	3-2
Overview	3-2
Network Settings	3-3
General Settings	3-3
Ethernet Configuration	3-4
User-defined Modbus Addressing	3-4
User-defined Modbus Addressing	3-4
Default Address	3-4
AOPC Server Settings	3-5
I/O Settings	3-5
DI Channels	3-5
DO Channels	3-6
AI Channels	3-7
AO Channels	3-9
RTD Channels	3-10
TC Channels	3-11
System Management	3-12
IP Accessibility	3-12
Network Connection	3-13
Firmware Update	3-13
Import System Config	3-13
Export System Config	3-13
Peer-to-peer Settings	3-14
Peer-to-peer Settings (1-50)	3-14
Sample Configuration	3-14
DO Safe Mode Settings	3-15
AO Safe Mode Settings	3-15
Change Password	3-16
Load Factory Default	3-16
Save/Restart	3-16
4. Using ioSearch	4-1
Introduction to ioSearch	4-2
ioSearch Main Screen	4-2
Main Screen Overview	4-2
Main Items	4-2
System	4-2
Sort	4-3
Quick Links	4-4
Main Function	4-4
Locate	4-4
Firmware Upgrade	4-4
Unlock	4-5
Import	4-5
Export	4-6
Change IP Address	4-6
Restart System	4-6
Reset to Default	4-7

5. Active OPC Server Lite.....	5-1
Introduction to Active OPC Server Lite.....	5-2
Active OPC Server Lite Specifications	5-2
Installing Active OPC Server Lite	5-2
Installing OPC Core Components	5-2
Active OPC Server Lite.....	5-3
Main Screen Overview.....	5-3
Menu Items.....	5-3
File	5-3
System	5-4
Sort.....	5-5
Quick Links.....	5-5
Tag Generation.....	5-5
Heartbeat Interval	5-6
Read/Write Privilege	5-7
OPC Test Client	5-7
A. Modbus/TCP Default Address Mappings	A-1
E1210 Modbus Mapping	A-2
E1211 Modbus Mapping	A-4
E1212 Modbus Mapping	A-5
E1214 Modbus Mapping	A-9
E1240 Modbus Mapping	A-11
E1241 Modbus Mapping	A-11
E1242 Modbus Mapping	A-12
E1260 Modbus Mapping	A-14
E1262 Modbus Mapping	A-14
B. Network Port Numbers.....	B-1
C. Factory Defaults	C-1
D. Pinouts.....	D-1
E. FCC Interference Statement.....	E-1
F. European Community (CE)	F-1

1

Introduction

The ioLogik E1200 series is a stand-alone remote Ethernet I/O server that can connect sensors and on/off switches for automation applications over Ethernet and IP-based networks.

The following topics are covered in this chapter:

- **Product Model Information**
- **Product Features**
- **Inside the Box**
- **Product Specifications**
- **Physical Dimensions**
- **Hardware Reference**
 - Panel Guide
 - LED Indicators

Product Model Information

Model	Description
ioLogik E1210	Remote Ethernet I/O with 2-port Ethernet switch and 16 DIs
ioLogik E1211	Remote Ethernet I/O with 2-port Ethernet switch and 16 DOs
ioLogik E1212	Remote Ethernet I/O with 2-port Ethernet switch, 8 DIs, and 8 DIOs
ioLogik E1214	Remote Ethernet I/O with 2-port Ethernet switch, 6 DIs, and 6 relays
ioLogik E1240	Remote Ethernet I/O with 2-port Ethernet switch and 8 AIs
ioLogik E1241	Remote Ethernet I/O with 2-port Ethernet switch and 4 AOs
ioLogik E1242	Remote Ethernet I/O with 2-port Ethernet switch and 4 AIs, 4DIs, and 4DIOs
ioLogik E1260	Remote Ethernet I/O with 2-port Ethernet switch and 6 RTDs
ioLogik E1262	Remote Ethernet I/O with 2-port Ethernet switch and 8 TCs
ioLogik E1210-T	Ethernet remote I/O with 2-port Ethernet switch and 16 DIs, -40 to 75°C operating temperature
ioLogik E1211-T	Ethernet remote I/O with 2-port Ethernet switch and 16 DOs, -40 to 75°C operating temperature
ioLogik E1212-T	Ethernet remote I/O with 2-port Ethernet switch, 8 DIs, and 8 DIOs, -40 to 75°C operating temperature
ioLogik E1214-T	Ethernet remote I/O with 2-port Ethernet switch, 6 DIs, and 6 Relays, -40 to 75°C operating temperature
ioLogik E1240-T	Ethernet remote I/O with 2-port Ethernet switch and 8 AIs, -40 to 75°C operating temperature
ioLogik E1241-T	Ethernet remote I/O with 2-port Ethernet switch and 4 AOs, -40 to 75°C operating temperature
ioLogik E1242-T	Ethernet remote I/O with 2-port Ethernet switch, 4 AIs, 4 DIs, and 4 DIOs, -40 to 75°C operating temperature
ioLogik E1260-T	Ethernet remote I/O with 2-port Ethernet switch and 6 RTDs, -40 to 75°C operating temperature
ioLogik E1262-T	Ethernet remote I/O with 2-port Ethernet switch and 8 TCs, -40 to 75°C operating temperature

Product Features

- Built-in 2-port Ethernet switch for daisy-chain topologies.
- Free support of Moxa's push-based Active OPC Server Lite.
 - Seamlessly connect to any SCADA system
 - Save 80% on network bandwidth
 - I/O response that's seven times faster
- User-defined Modbus/TCP addressing
- MXIO programming library for Windows and WinCE VB/VC.NET and Linux C APIs
- Web configuration with Import/Export function
- Peer-to-peer transmission of I/O signals over Ethernet without controller

Inside the Box

The ioLogik E1200 is shipped with the following items:

- ioLogik E1200 Remote Ethernet I/O Server.
- Document and Software CD.
- Quick Installation Guide.

NOTE: Notify your sales representative if any of the above items are missing or damaged.

Product Specifications

ioLogik E1210

Digital Input

Sensor Type: NPN, PNP, and Dry contact

I/O Mode: DI or Event Counter

Dry Contact:

- Logic 0: short to GND
- Logic 1: open

Wet Contact:

- Logic 0: 0 to 3 VDC
- Logic 1: 10 to 30 VDC (DI COM to DI)

Isolation: 3K VDC or 2K Vrms

Counter/Frequency: 250 Hz, power off storage

Power Requirements

Power Consumption: 111 mA @ 24 VDC

MTBF (mean time between failures)

Time: 671,345 hrs

Database: Telcordia (Bellcore)

ioLogik E1211

Digital Output

I/O Mode: DO or Pulse Output

Pulse Wave Width/Frequency: 1 ms/500 Hz

Over-voltage Protection: 45 VDC

Over-current Protection: 2.6 A (4 channels @ 650 mA)

Over-temperature Shutdown: 175°C (typical), 150°C (min.)

Current Rating: 200 mA per channel

Isolation: 3K VDC or 2K Vrms

Power Requirements

Power Consumption: 208 mA @ 24 VDC

MTBF (mean time between failures)

Time: 221,662 hrs

Database: Telcordia (Bellcore)

ioLogik E1212

Digital Input

Sensor Type: NPN, PNP, and Dry contact

I/O Mode: DI or Event Counter

Dry Contact:

- Logic 0: short to GND
- Logic 1: open

Wet Contact:

- Logic 0: 0 to 3 VDC
- Logic 1: 10 to 30 VDC (DI COM to DI)

Isolation: 3K VDC or 2K Vrms

Counter/Frequency: 250 Hz, power off storage

Digital Output

I/O Mode: DO or Pulse Output

Pulse Wave Width/Frequency: 1 ms/500 Hz

Over-voltage Protection: 45 VDC

Over-current Protection: 2.6 A (4 channels @ 650 mA)

Over-temperature Shutdown: 175°C (typical), 150°C (min.)

Current Rating: 200 mA per channel

Isolation: 3K VDC or 2K Vrms

Power Requirements

Power Consumption: 155 mA @ 24 VDC

MTBF (mean time between failures)

Time: 179,098 hrs

Database: Telcordia (Bellcore)

ioLogik E1214**Digital Input**

Sensor Type: NPN, PNP, and Dry contact

I/O Mode: DI or Event Counter

Dry Contact:

- Logic 0: short to GND
- Logic 1: open

Wet Contact:

- Logic 0: 0 to 3 VDC
- Logic 1: 10 to 30 VDC (DI COM to DI)

Isolation: 3K VDC or 2K Vrms

Counter/Frequency: 250 Hz, power off storage

Relay Output

Type: Form A (N.O.) relay outputs, 5A

Contact Rating: 5 A @ 30 VDC, 5 A @ 250 VAC, 5 A @ 110 VAC

Inductance Load: 2 A

Resistance Load: 5 A

Breakdown Voltage: 500 VAC

Relay On/Off Time: 1500 ms (Max.)

Initial Insulation Resistance: 1G min. @ 500 VDC

Expected Life: 100,000 times (Typical)

Initial Contact Resistance: 30 milli-ohms (Max.)

Pulse Output: 0.3 Hz at rated load

Power Requirements

Power Consumption: 188 mA @ 24 VDC

MTBF (mean time between failures)

Time: 808,744 hrs

Database: Telcordia (Bellcore)

ioLogik E1240**Analog Input**

Type: Differential input

Resolution: 16 bits

I/O Mode: Voltage / Current

Input Range: 0 to 10 VDC, 4 to 20 mA

Accuracy:

±0.1% FSR @ 25°C

±0.3% FSR @ -10 and 60°C

Sampling Rate (all channels): 12 samples/sec

Input Impedance: 10M ohms (minimum)

Built-in Resistor for Current Input: 120 ohms

Power Requirements

Power Consumption: 121 mA @ 24 VDC

MTBF (mean time between failures)

Time: 474,053 hrs

Database: Telcordia (Bellcore)

ioLogik E1241

Analog Output

Resolution: 12 bits

Output Range: 0 to 10 VDC, 4 to 20 mA

Voltage Output: 10 mA (Max.)

Accuracy:

±0.1% FSR @ 25°C

±0.3% FSR @ -10 and 60°C

Load Resistor:

- Internal power: 400 ohms
- External 24V power: 1000 ohms

Power Requirements

Power Consumption: 194 mA @ 24 VDC

MTBF (mean time between failures)

Time: 888,656 hrs

Database: Telcordia (Bellcore)

ioLogik E1242

Analog Input

Type: Differential input

Resolution: 16 bits

I/O Mode: Voltage / Current

Input Range: 0 to 10 VDC, 4 to 20 mA

Accuracy:

±0.1% FSR @ 25°C

±0.3% FSR @ -10 and 60°C

Sampling Rate (all channels): 12 samples/sec

Input Impedance: 10M ohms (minimum)

Built-in Resistor for Current Input: 120 ohms

Digital Input

Sensor Type: NPN, PNP, and Dry contact

I/O Mode: DI or Event Counter

Dry Contact:

- Logic 0: short to GND
- Logic 1: open

Wet Contact:

- Logic 0: 0 to 3 VDC
- Logic 1: 10 to 30 VDC (DI COM to DI)

Isolation: 3K VDC or 2K Vrms

Counter/Frequency: 250 Hz, power off storage

Digital Output

I/O Mode: DO or Pulse Output

Pulse Wave Width/Frequency: 1 ms/500 Hz

Over-voltage Protection: 45 VDC

Over-current Protection: 2.6 A (4 channels @ 650 mA)

Over-temperature Shutdown: 175°C (typical), 150°C (min.)

Current Rating: 200 mA per channel

Isolation: 3K VDC or 2K Vrms

Power Requirements

Power Consumption: 140 mA @ 24 VDC

MTBF (meantime between failures)

Time: 502,210 hrs

Database: Telcordia (Bellcore)

ioLogik E1260

RTD

Input Type: PT50, PT100, PT200, PT500, PT1000;

Resistance of 10 ohms, 20 ohms, and 100 ohms

Sampling Rate: 12 samples/sec (all channels)

Resolution: 16 bits

Accuracy:

±0.1% FSR @ 25°C

±0.3% FSR @ -10 and 60°C

Input Impedance: 625K ohms

Power Requirements

Power Consumption: 110 mA @ 24 VDC

MTBF (meantime between failures)

Time: 660,260 hrs

Database: Telcordia (Bellcore)

ioLogik E1262

Thermocouple Input

Sensor Type: J, K, T, E, R, S, B, N

Mili Volt Type: ±78.126 mV, ±39.062 mV, ±19.532 mV

Fault and Overvoltage protection: ±35 VDC (power off); +30 VDC, -25 VDC (power on)

Sampling Rate: 12 samples/sec (all channels)

Resolution: 16 bits

Accuracy:

±0.1% FSR @ 25°C

±0.3% FSR @ -10 and 60°C

Input Impedance: 10M ohms

Power Requirements

Power Consumption: 119 mA @ 24 VDC

MTBF (meantime between failures)

Time: 631,418 hrs

Database: Telcordia (Bellcore)

Common Specifications

LAN

Ethernet: 2 x 10/100 Mbps switch ports, RJ45

Protection: 1.5 KV magnetic isolation

Protocols: Modbus/TCP, TCP/IP, UDP, DHCP, Bootp, HTTP

Power Requirements

Power Input: 24 VDC nominal, 12 to 36 VDC

Physical Characteristics

Wiring: I/O cable max. 14 AWG

Dimensions: 27.8 x 124 x 84 mm (1.09 x 4.88 x 3.31 in)

Weight: under 200 g

Environmental Limits

Operating Temperature:

Standard Models: -10 to 60°C (14 to 140°F)

Wide Temperature Models: -40 to 75°C (-40 to 167°F)

Storage Temperature: -40 to 85°C (-40 to 185°F)

Ambient Relative Humidity: 5 to 95% (non-condensing)

Standards and Certifications

Safety: UL 508

EMI: FCC Part 15 Subpart B Class A

EMS: IEC 61000-4, IEC 61000-6

Shock: IEC 60068-2-27

Freefall: IEC 60068-2-32

Vibration: IEC 60068-2-6

Note: Please check Moxa's website for the most up-to-date certification status.

Warranty

Warranty Period: 5 years (excluding ioLogik E1214*)

Details: See www.moxa.com/warranty

***Because of the limited lifetime of power relay, products that use this component are covered by a 2-year warranty.**

Physical Dimensions

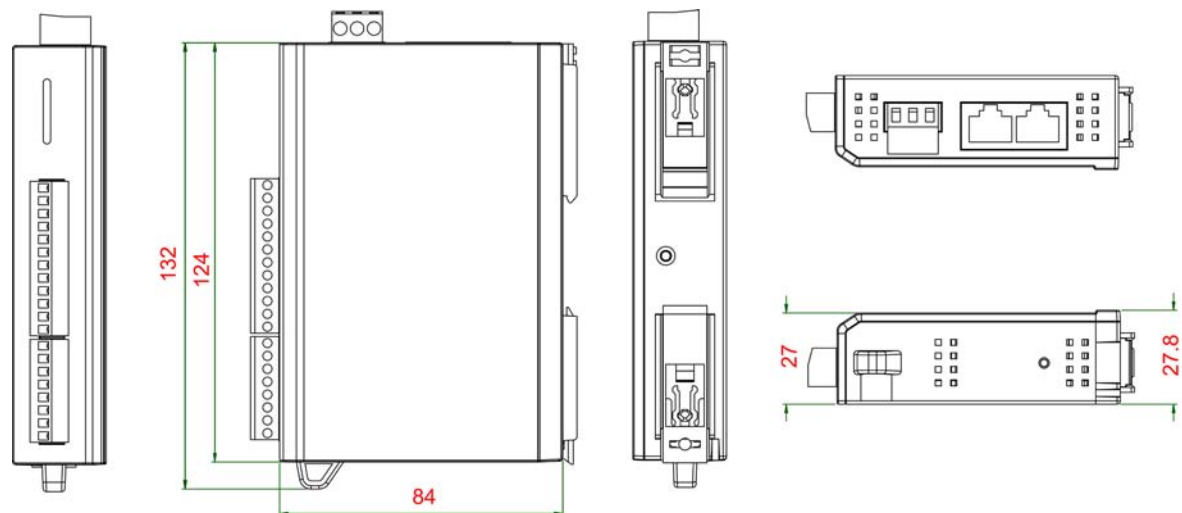

Unit=mm

Hardware Reference

Panel Guide

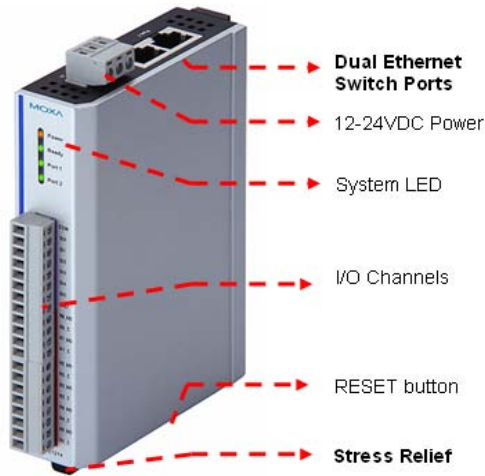

NOTE The reset button restarts the server and resets all settings to factory defaults. Use a pointed object such as a straightened paper clip to hold in the reset button for 5 sec. The factory defaults will be loaded once the Ready LED turns green again. You may then release the reset button.

LED Indicators

LED	State	Description
Power	Amber	System power is ON
	OFF	System power is OFF
Ready	Green	System is ready
	Flashing	Flashes every 1 sec when the Locate function is triggered
	Flashing	Flashes every 0.5 sec when the firmware is being upgraded
	Flashing	Cycle on/off period of 0.5 sec. represents "Safe Mode"
	OFF	System is not ready.
Port 1	Green	Ethernet connection enabled
	Flashing	Transmitting or receiving data
Port 2	Green	Ethernet connection enabled
	Flashing	Transmitting or receiving data

2

Initial Setup

This chapter describes how to install the ioLogik E1200.

The following topics are covered in this chapter:

❑ Hardware Installation

- Connecting the Power
- Grounding the ioLogik E1200
- Connecting to the Network
- Jumper Settings
- I/O Wiring Diagrams

❑ Software Installation

❑ Load Factory Default

Hardware Installation

Connecting the Power

Connect the 12 to 36 VDC power line to the ioLogik E1200’s terminal block on the top panel. If power is properly supplied, the Power LED will glow a solid amber color.



ATTENTION

Disconnect the power cord before installing or wiring your ioLogik E1200. Do not exceed the maximum current for the wiring. Determine the maximum possible current for each power wire and common wire. Observe all electrical codes dictating the maximum current allowable for each wire size. If the current exceeds the maximum rating, the wiring could overheat, causing serious damage to your equipment. For safety reasons, the wires attached to the power should be at least 2 mm in diameter.

Grounding the ioLogik E1200

The ioLogik E1200 is equipped with a grounding point on the terminal block located on the top panel.

Connect the ground pin () if earth ground is available.

Connecting to the Network

The ioLogik E1200 has two built-in Ethernet switch ports for connecting a standard direct or cross-over Ethernet cable from RJ45 port to either the host PC or another ioLogik E1200 device. For initial setup of the ioLogik E1200, it is recommended that the ioLogik E1200 be configured using a direct connection to a host computer rather than remotely over the network.

Configure the host PC’s IP address to 192.168.127.xxx (where xxx ranges from 001 to 253). When using Windows, you will need to do the configuration from the Control Panel.

ioLogik E1200 Default IP Address	Default Netmask	Default Gateway
192.168.127.254	255.255.255.0	None

Use the web console or ioSearch configuration utility to connect to the ioLogik E1200. Once the ioLogik E1200 has been detected, modify the settings as needed for your network environment, and then restart the server. Refer to Chapters 3 and 4 or further details.

Jumper Settings

The ioLogik E1212, E1240, and E1242 require configuring the jumpers inside the enclosure. Remove the screw on the back panel and open the cover to configure the jumpers.

DIO mode configuration is as follows (default is DO Mode)

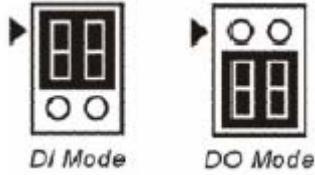

Analog mode configuration is as follows (default is Voltage Mode)

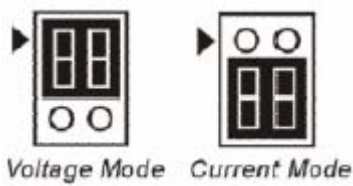

I/O Wiring Diagrams

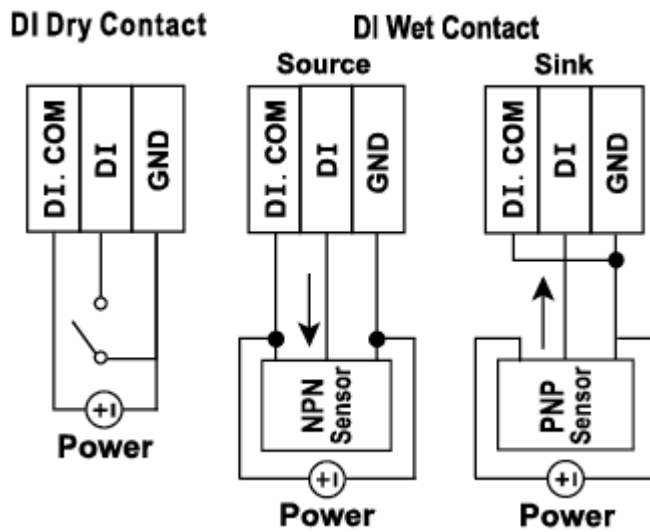

ATTENTION

Remove the screw on the back panel and open the cover to configure the jumpers.

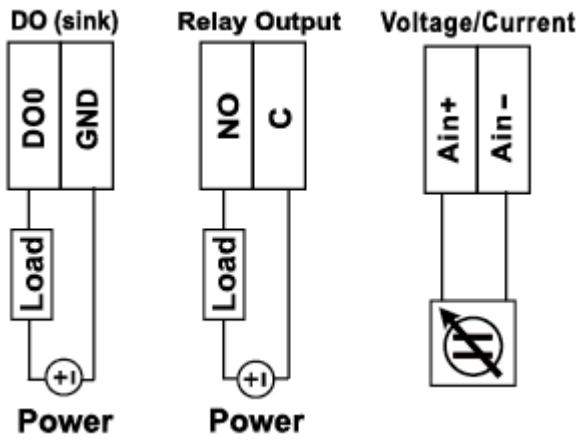

0-10V 4-20 mA

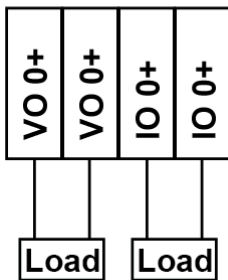

2-Wire RTD

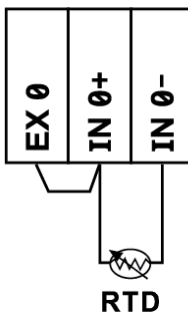

3-Wire RTD

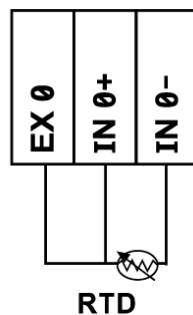

Voltage

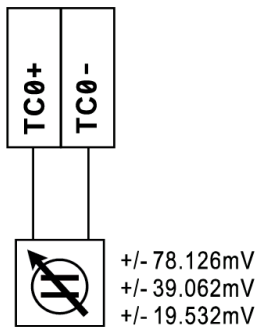

Thermocouple

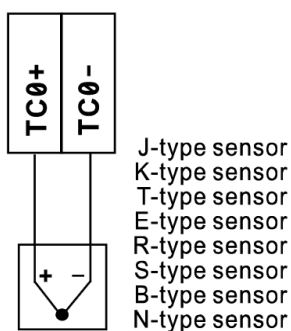

Software Installation

ioSearch is a search utility that helps the user locate ioLogik E1200 devices on the local network. Find the ioSearch utility in the Document and Software CD under Software → ioSearch, or download the latest version from Moxa's website.

1. Installing from the CD: Insert the Document and Software CD into the host computer. In the root directory of the CD, locate and run SETUP.EXE. The installation program will guide you through the installation process and install the ioSearch utility. You can also install the MXIO DLL library separately.
2. Open ioSearch: After installation is finished, run ioSearch from Start Program Files MOXA →IO Server Utility ioSearch
3. Search the network for the server: On the menu bar, select System Auto Scan Active Ethernet I/O Server. A dialog window will pop up. Click Start Search to begin searching for the ioLogik E1200.

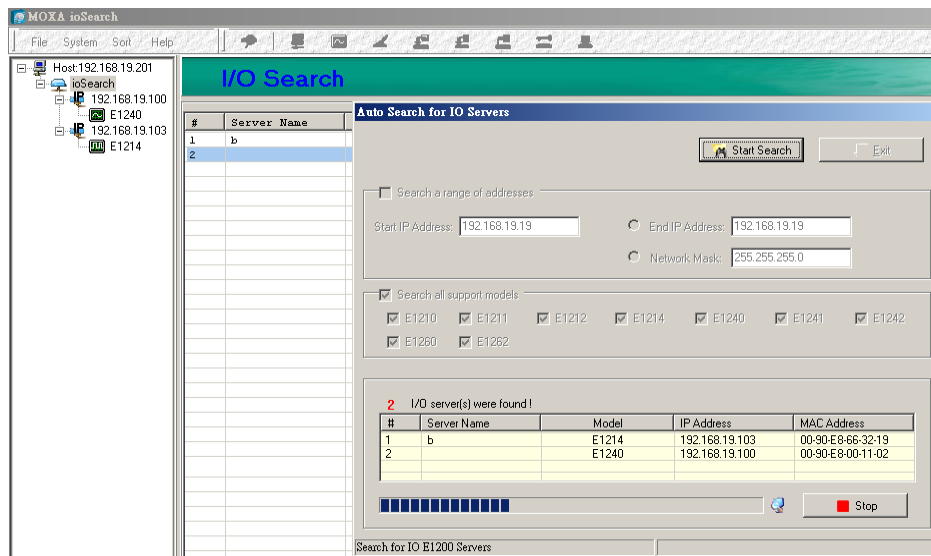

If multiple ioLogik E1200 units are installed on the same network, remember that each unit has the same default IP address. You will need to assign a different IP address to each unit to avoid IP conflicts.

Load Factory Default

There are three ways to restore the ioLogik E1200 to the factory default.

1. Hold the RESET button for 5 seconds.
2. Right click the specified ioLogik in the ioSearch utility and select "Reset to Default".
3. Select "Load Factory Default" from the web console.

Using the Web Console

The iLogik E1200's main configuration and management utility is the built-in web console, which can be used to configure a wide range of options.

The following topics are covered in this chapter:

❑ **Introduction to the Web Console**

❑ **Overview**

❑ **Network Settings**

- General Settings
- Ethernet Configuration

❑ **User-defined Modbus Addressing**

- User-defined Modbus Addressing
- Default Address

❑ **AOPC Server Settings**

❑ **I/O Settings**

- DI Channels
- DO Channels
- AI Channels
- AO Channels
- RTD Channels
- TC Channels

❑ **System Management**

- IP Accessibility
- Network Connection
- Firmware Update
- Import System Config
- Export System Config

❑ **Peer-to-peer Settings**

- Peer-to-peer Settings (1-50)
- Sample Configuration
- DO Safe Mode Settings
- AO Safe Mode Settings

❑ **Change Password**

❑ **Load Factory Default**

❑ **Save/Restart**

Introduction to the Web Console

The ioLogik E1200 web console is a browser-based configuration utility. When the ioLogik E1200 is connected to your network, you may enter the server’s IP address in your web browser to access the web console.

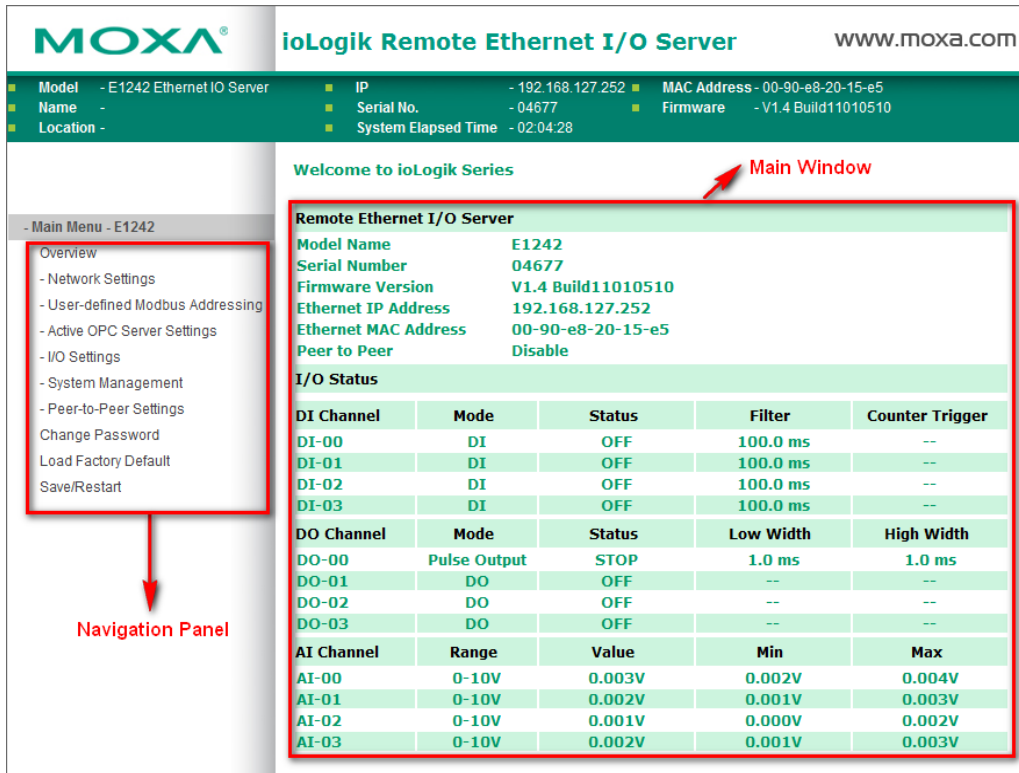

The left panel is the navigation panel and contains an expandable menu tree for navigating among the various settings and categories. When you click on a menu item in the navigation panel, the main window will display the corresponding options for that item. Configuration changes can then be made in the main window. For example, if you click on **Network Settings** in the navigation panel, the main window will show a page of basic settings that you can configure.

You must click on the **Submit** button after making configuration changes. The **Submit** button will be located at the bottom of every page that has configurable settings. If you navigate to another page without clicking the **Submit** button, your changes will not be retained.

Submitted changes will not take effect until they are saved and the ioLogik E1200 is restarted! You may save and restart the server in one step by clicking on the **Save/Restart** button after you submit a change. If you need to make several changes before restarting, you may save your changes without restarting by selecting **Save/Restart** in the navigation panel. If you restart the ioLogik E1200 without saving your configuration, the ioLogik E1200 will discard all submitted changes.

Overview

The Overview page contains basic information about the ioLogik E1200, including the model name, serial number, firmware version, MAC address, and current IP address. Most importantly, you can see the current I/O status by hitting the F5 key on the computer keyboard to refresh the page.

The screenshot shows the web console interface for an ioLogik E1242 Remote Ethernet I/O Server. At the top, the MOXA logo and product name are displayed. A status bar provides key information: Model (E1242 Ethernet I/O Server), Name, Location, IP (192.168.127.252), Serial No. (04677), System Elapsed Time (02:04:28), MAC Address (00-90-e8-20-15-e5), and Firmware (V1.4 Build11010510).

A main menu on the left lists navigation options such as Overview, Network Settings, User-defined Modbus Addressing, Active OPC Server Settings, I/O Settings, System Management, Peer-to-Peer Settings, Change Password, Load Factory Default, and Save/Restart.

The central area displays a 'Welcome to ioLogik Series' message and a 'Remote Ethernet I/O Server' configuration summary:

- Model Name: E1242
- Serial Number: 04677
- Firmware Version: V1.4 Build11010510
- Ethernet IP Address: 192.168.127.252
- Ethernet MAC Address: 00-90-e8-20-15-e5
- Peer to Peer: Disable

Below this is the 'I/O Status' section, which contains three tables:

DI Channel	Mode	Status	Filter	Counter Trigger
DI-00	DI	OFF	100.0 ms	--
DI-01	DI	OFF	100.0 ms	--
DI-02	DI	OFF	100.0 ms	--
DI-03	DI	OFF	100.0 ms	--

DO Channel	Mode	Status	Low Width	High Width
DO-00	Pulse Output	STOP	1.0 ms	1.0 ms
DO-01	DO	OFF	--	--
DO-02	DO	OFF	--	--
DO-03	DO	OFF	--	--

AI Channel	Range	Value	Min	Max
AI-00	0-10V	0.003V	0.002V	0.004V
AI-01	0-10V	0.002V	0.001V	0.003V
AI-02	0-10V	0.001V	0.000V	0.002V
AI-03	0-10V	0.002V	0.001V	0.003V

Network Settings

General Settings

On the General Settings page, you can assign a server name and location to assist you in differentiating between different ioLogik E1200 units. You may also configure the Modbus/TCP idle interval or enable the Communication Watchdog function.

General Settings

I/O Server Settings

Server Name

Server Location

Enable Modbus/TCP idle connection timeout interval sec (default:60, 0~65535)

Enable communication watchdog sec (default:60, 0~65535)

The Connection Watchdog activates the safe status (Safe Mode) when the ioLogik E1200 loses its network connection for the specified amount of time. Safe Mode is designed especially for products that have output channels to output a suitable value or status when the ioLogik E1200 cannot be controlled by a remote PC (due to network failure, for example). By default, the Watchdog is disabled. Users can configure how each output channel responds on the I/O Settings page.

To enable the Watchdog, check **Enable connection watchdog**, set the timeout value, and then restart the server. With Watchdog enabled, the ioLogik E1200 will enter Safe Mode after there is a disruption in communication that exceeds the time specified.

Ethernet Configuration

On the Ethernet Configuration page, you can set up a static or dynamic IP address for the ioLogik E1200, and configure the subnet mask and gateway address.

Ethernet Configuration

Ethernet Parameters

IP Configuration	Static
IP Address	192.168.127.254
Subnet Mask	255.255.255.0
Gateway	0.0.0.0

Submit

User-defined Modbus Addressing

User-defined Modbus Addressing

The input and output address can be configured in a different format on a specific settings page. Check the "Enable User-defined Modbus Addressing" box, select the Modbus function, and then configure the start address of each item.

User-defined Modbus Addressing

Enable User-defined Modbus Addressing

User-defined Modbus address							
No.	Description	User-defined Start Address (DEC)	Function Code	Read/Write	Reference Address (DEC)	Total Channels	Data Type
1	DI Value	0001	02:INPUT STATUS	R	10001	16	1 bit
2	DI Counter Value (Double Word)	0017	01:COIL STATUS	R	30017	16	2 WORD
3	DI Value All Channel (Ch0-Ch15)	0049	02:INPUT STATUS	R	30049	1	1 WORD
4	DI Counter Start/Stop	0257	03:HOLDING REGISTER	RW	00257	16	1 bit
5	DI Counter Clear	0273	04:INPUT REGISTER	RW	00273	16	1 bit

Submit

Load Default



ATTENTION

Disable the user-defined modbus addressing function if using the MXIO(.NET) library or using Active OPC Server to control or monitor the ioLogik E1200's I/O Status.

Default Address

On this settings page, you can view the default Modbus address for all I/O devices. The page only displays the start address of each item. For example, if the DI Value starts from 10001, then the 1st DI channel's Modbus address is 10001 and the 2nd DI is 10002.

Default Modbus Address

Default Modbus address							
No.	Description	User-defined Start Address (DEC)	Function Code	Read/Write	Reference Address (DEC)	Total Channels	Data Type
1	DI Value	0001	02:INPUT STATUS	R	10001	16	1 BIT
2	DI Counter Value Double Word	0017	04:INPUT REGISTER	R	30017	16	2 WORD
3	DI Value All Channel (Ch0-Ch15)	0049	04:INPUT REGISTER	R	30049	1	1 WORD
4	DI Counter Start/Stop	0257	01:COIL STATUS	RW	00257	16	1 BIT
5	DI Counter Clear	0273	01:COIL STATUS	RW	00273	16	1 BIT

AOPC Server Settings

Refer to the **Tag Generation** section in **Chapter 5: Active OPC Server Lite**.

I/O Settings

DI Channels

The status of each DI (digital input) channel appears on the DI Channels page.

DI Channel Settings

Refresh page

DI Channel	Mode	Status	Filter	Counter Trigger
DI-00	DI	OFF	100.0 ms	--
DI-01	DI	OFF	100.0 ms	--
DI-02	DI	OFF	100.0 ms	--
DI-03	DI	OFF	100.0 ms	--
DI-04	DI	OFF	100.0 ms	--
DI-05	DI	OFF	100.0 ms	--
DI-06	DI	OFF	100.0 ms	--
DI-07	DI	OFF	100.0 ms	--
DI-08	DI	OFF	100.0 ms	--
DI-09	DI	OFF	100.0 ms	--
DI-10	DI	OFF	100.0 ms	--
DI-11	DI	OFF	100.0 ms	--
DI-12	DI	OFF	100.0 ms	--
DI-13	DI	OFF	100.0 ms	--
DI-14	DI	OFF	100.0 ms	--
DI-15	DI	OFF	100.0 ms	--

You can also configure each channel's digital input mode and parameters by clicking on the channel. DI channels can operate in DI mode or Event Counter mode.

DI Channel 0 Settings

Mode	Filter	Counter Trigger	Counter Start
1. Current Setting			
DI	100		
2. Safe Status Setting			
3. Safe Status Setting			
4. Save Status On Power Failure			
5. Reset Counter			
<input type="checkbox"/> Apply to all DI channels			
Alias name of channel			
DI			
Alias name of logic 0			
OFF			
Alias name of logic 1			
ON			
		Submit	Close

For Event Counter mode, configure “Lo to Hi,” “Hi to Lo,” or “Both” to trigger the counter. The counter should be set to either **start**, or **stop**. If it is in **stop** mode, the counter can be activated by the Modbus command. Make sure that the Counter Filter is not set to 0; otherwise, the counter will never be activated.

The alias name and the logic definition can also be configured on this page.

DO Channels

On the DO Channels page, configure each DO (digital output) channel by clicking on the channel. DO Channels can operate in DO mode or Pulse Output mode. In DO mode, output is either on or off. In Pulse Output mode, configure the low width and high width to generate a square wave.

DO Channel Settings

Refresh page

DO Channel	Mode	Status	Low Width	High Width
DO-00	DO	OFF	--	--
DO-01	DO	OFF	--	--
DO-02	DO	OFF	--	--
DO-03	DO	OFF	--	--
DO-04	DO	OFF	--	--
DO-05	DO	OFF	--	--
DO-06	DO	OFF	--	--
DO-07	DO	OFF	--	--

The **Power On Setting** field is used to specify the channel’s configuration when the ioLogik E1200 is powered on, and the **Safe Status Setting** field specifies the channel’s configuration when the ioLogik E1200 enters Safe Mode. Note that Safe Status is controlled by the Connection Watchdog, which is disabled by default. If the Connection Watchdog is disabled, the ioLogik E1200 will never enter Safe Mode and your Safe Status settings will have no effect.

DO Channel 0 Settings

Mode	DO Status	Pulse Low*	Pulse High*	Pulse Count	Pulse Start
1. Current Setting					
DO	Off				
DO	Off				
Pulse Output	Off				
3. Safe Status Setting					
	Off				
<input type="checkbox"/> Apply to all DO channels					
4. Alias Name					
Alias name of channel					
DO					
Alias name of logic 0					
OFF					
Alias name of logic 1					
ON					
<input type="button" value="Submit"/> <input type="button" value="Close"/>					

Users may also configure the alias name and the logic definition on this page.



ATTENTION

Remove the screw on the back panel and open the cover to configure the jumpers for input or output selection of the DIO channels. Refer to chapter 2 for detailed jumper settings.

AI Channels

The current status of each AI (analog input) channel can be viewed on the AI Channels page.

AI Channel Settings

AI Channel	Range	Value	Min.	Max.
AI-00	0-10V	0.010V	0.007V	0.010V
AI-01	0-10V	0.009V	0.009V	0.012V
AI-02	0-10V	0.009V	0.006V	0.009V
AI-03	0-10V	0.007V	0.007V	0.010V
AI-04	0-10V	0.010V	0.010V	0.013V
AI-05	0-10V	0.009V	0.009V	0.012V
AI-06	0-10V	0.008V	0.008V	0.011V
AI-07	0-10V	0.009V	0.009V	0.012V

Click on a specific channel to enable or disable the AI channel by checking the "Enable AI Channel" box. The Auto Scaling and Slope-intercept function of the AI value can be defined on this page.

AI Channel #0 Settings

Enable AI Channel

AI Input Range

0-10V

Auto Scaling Settings

Disable Scaling
 Enable Point-Slope formula

Actual (x.xxx)		Scaled (x.xxx)	
Min (n1)	0	Min (n2)	0
Max (m1)	10	Max (m2)	10
Unit	V	Unit	V

*Result = $n2 + (input - n1) \times [(m2-n2)/(m1-n1)]$

Enable Slope-intercept

M= 1
D= 0
Unit V

*Result = $M \times Input + D$

Apply to All Channels

Alias Name Settings

Alias Name of Channel AI

Submit Close



ATTENTION

Remove the screw on the back panel and open the cover to configure the jumpers to select voltage or current measurement for the AI channels. Refer to chapter 2 for detailed jumper settings.

The Auto scaling function maps the original AI value linearly to a scaled value. Note that the scaled value’s Modbus address differs from the original value.

Auto Scaling Settings

- Disable Scaling
- Enable Point-Slope formula

Actual (x.xxx)		Scaled (x.xxx)	
Min (n1)	0.000	Min (n2)	0.000
Max (m1)	10.000	Max (m2)	1000.000
Unit	V	Unit	ppm

*Result = $n2 + (input - n1) \times [(m2-n2)/(m1-n1)]$

The slope-intercept function is used to compensate when the measurement requires a slight adjustment.

- Enable Slope-intercept

M= 1.1
D= 0.02
Unit V

*Result = $M \times Input + D$

AO Channels

The current status of each AO (analog output) channel can be viewed on the AO Channel page.

AO Channel Settings

Refresh page

AO Channel	Range	Value
AO-00	0-10V	0.000V/0.000V
AO-01	0-10V	0.000V/0.000V
AO-02	0-10V	0.000V/0.000V
AO-03	0-10V	0.000V/0.000V

Click on a specific channel to access the AO channel settings, and then select the "Enable AO Channel" box.

The Auto Scaling function of the AO value can be defined on this page.

AO Channel 0 Settings

Enable AO Channel

Analog Output Range	Analog Output Value
Current Range	
0-10V 0-10V 4-20mA	0 [0-4095]
Power On Setting	
	0 [0-4095]
Safe Status Setting	
	0 [0-4095]

Auto Scaling Settings

Disable Scaling
 Enable Point-Slope formula

	Actual (x.xxx)		Scaled (x.xxx)
Min (n1)		Min (n2)	
Max (m1)		Max (m2)	
Unit		Unit	

*Result = $n2 + (input - n1) \times [(m2-n2)/(m1-n1)]$
 Apply to All Channels

Alias Name Settings

Alias Name of Channel: AO

Submit Close

The Auto scaling function maps the original AO output linearly to a scaled value. Note that the scaled value's Modbus address differs from the original value.

Auto Scaling Settings

Disable Scaling
 Enable Point-Slope formula

	Actual (x.xxx)		Scaled (x.xxx)
Min (n1)	4	Min (n2)	0
Max (m1)	20	Max (m2)	100
Unit	mA	Unit	%

*Result = $n2 + (input - n1) \times [(m2-n2)/(m1-n1)]$
 Apply to All Channels

RTD Channels

The current status of each RTD (Resistance Temperature Detector) channel can be viewed on the RTD Channel page.

RTD Channel Settings

Refresh page

Clear Max. and Min.

RTD Channel	Sensor Type	Range	Status	Value	Min	Max
RTD-00	PT 100	-200 ~ 850°C	Enabled	--	--	--
RTD-01	PT 100	-200 ~ 850°C	Enabled	--	--	--
RTD-02	PT 100	-200 ~ 850°C	Enabled	--	--	--
RTD-03	PT 100	-200 ~ 850°C	Enabled	--	--	--
RTD-04	PT 100	-200 ~ 850°C	Enabled	--	--	--
RTD-05	PT 100	-200 ~ 850°C	Enabled	--	--	--

Click on a specific channel to access the RTD channel settings.

Select the "Enable RTD Channel" box and then select the sensor type that meets the physical attachment to the ioLogik E1200.

RTD Channel 0 Settings

Enable RTD Channel

RTD Sensor Type	Range	Unit
PT 100 ($\alpha = 0.00385$)	-200 ~ 850	°C

Apply to All Channels

Alias Name Settings

Alias Name of Channel: RTD

Submit

Close

WARNING: Be sure to Save/Restart your settings

The ioLogik E1200 allows you to calibrate the temperature sensors. In each channel configuration section, follow the instructions and click **Calibrate** button to start the RTD sensor calibration. Each calibration requires around 30 seconds (per channel).

Calibration

Select Channel : Channel 0

Sensor Type: PT 100

1. Ensure the sensor is connected.
2. Ensure the channel and its sensor type is correctly selected.
3. Put the sensor into a glass that contains a mixture of ice and water.
4. Click on the "Calibrate" button.
5. Wait until the page shows "Calibration Completed".

NOTE:

1. Do not remove the sensor from the ice water during calibration.
2. Load factory default will clear the current calibrated settings.

Calibrate Home

NOTE: Resistance types of sensors are not supported to be calibrated.

The ioLogik E1200 allows you to manually adjust the current temperature reading. In each channel configuration section, select the channel, apply the offset value, and click the "Submit" button to perform the task.

Offset

Channel	Offset	Unit
Select Channel : Channel 0	1.8	°C

Submit Home

NOTE: Offset range: -1000.0 to +1000.0, unit = 0.1 °C/°F.

TC Channels

The current status of each TC (Thermocouple) channel can be viewed on the TC Channel page.

TC Channel Settings

Refresh page Clear Max. and Min.

TC Channel	Sensor Type	Range	Status	Value	Min	Max
TC-00	E TYPE	-200 ~ 900°C	Enabled	--	--	--
TC-01	K TYPE	-200 ~ 1250°C	Enabled	--	--	--
TC-02	K TYPE	-200 ~ 1250°C	Enabled	--	--	--
TC-03	K TYPE	-200 ~ 1250°C	Enabled	--	--	--
TC-04	K TYPE	-200 ~ 1250°C	Enabled	--	--	--
TC-05	K TYPE	-200 ~ 1250°C	Enabled	--	--	--
TC-06	K TYPE	-200 ~ 1250°C	Enabled	--	--	--
TC-07	K TYPE	-200 ~ 1250°C	Enabled	--	--	--

Click on a specific channel to access the enabling or disabling of the TC channel. Select the "Enable TC Channel" box and then select the sensor type that meets the physical attachment to the ioLogik E1200.

TC Channel 0 Settings

Enable TC Channel

TC Sensor Type	Range	Unit
E TYPE	-200 ~ 900	°C

Apply to All Channels

Alias Name Settings

Alias Name of Channel TC

Submit Close

The ioLogik E1200 allows you to calibrate the temperature sensors. In each channel configuration section, follow the instructions and click the "Calibrate" button to start the TC sensor calibration. Each calibration requires about 30 seconds (per channel).

Calibration

Select Channel : Channel 0

Sensor Type: E TYPE

1. Ensure the sensor is connected.
2. Ensure the channel and its sensor type is correctly selected.
3. Put the sensor into a glass that contains a mixture of ice and water.
4. Click on the "Calibrate" button.
5. Wait until the page shows "Calibration Completed".

NOTE:

1. Do not remove the sensor from the ice water during calibration.
2. Load factory default will clear the current calibrated settings.

Calibrate Home

NOTE: Milli-volts types of sensors are not supported to be calibrated.

The ioLogik E1200 allows you to manually adjust the current temperature reading. In each channel configuration section, select the channel, apply the offset value, and click the “Submit” button to perform the task.

Offset

Channel	Offset	Unit
Select Channel : Channel 0	1.8	°C
<input type="button" value="Submit"/>	<input type="button" value="Home"/>	

NOTE: Offset range: -1000.0 to +1000.0, unit = 0.1 °C/°F.

System Management

IP Accessibility

You can control network access to the ioLogik E1200 from the IP Accessibility page by only allowing access from specific IP addresses. When the accessible IP list is enabled, a host’s IP address must be listed in order to gain access to the ioLogik E1200.

Accessibility IP List

Enable the accessibility IP List (if unchecked, all connection requests will be accepted.)

No.	Enable	IP Address	Netmask
1	<input checked="" type="checkbox"/>	192.168.127.253	255.255.255.255
2	<input checked="" type="checkbox"/>	192.168.1.0	255.255.255.0
3	<input type="checkbox"/>	0.0.0.0	255.255.255.0
4	<input type="checkbox"/>	0.0.0.0	255.255.255.0
5	<input type="checkbox"/>	0.0.0.0	255.255.255.0
6	<input type="checkbox"/>	0.0.0.0	255.255.255.0
7	<input type="checkbox"/>	0.0.0.0	255.255.255.0
8	<input type="checkbox"/>	0.0.0.0	255.255.255.0
9	<input type="checkbox"/>	0.0.0.0	255.255.255.0
10	<input type="checkbox"/>	0.0.0.0	255.255.255.0

Specify a range of addresses by using a combination of an IP address and netmask, as follows:

To allow access to a specific IP address

Enter the IP address in the corresponding field; enter **255.255.255.255** for the netmask.

To allow access to hosts on a specific subnet

For both the IP address and netmask, use **0** for the last digit (e.g., **192.168.1.0** and **255.255.255.0**).

To allow unrestricted access

Deselect the **Enable the accessible IP list** option.

Refer to the following table for additional configuration examples.

Allowed Hosts	IP address/Netmask
Any host	Disable
192.168.1.120	192.168.1.120 / 255.255.255.255
192.168.1.1 to 192.168.1.254	192.168.1.0 / 255.255.255.0

Allowed Hosts	IP address/Netmask
192.168.0.1 to 192.168.255.254	192.168.0.0 / 255.255.0.0
192.168.1.1 to 192.168.1.126	192.168.1.0 / 255.255.255.128
192.168.1.129 to 192.168.1.254	192.168.1.128 / 255.255.255.128

Network Connection

TCP connections from other hosts appear on the Network Connection page. This information can assist you with managing your devices.

Network Connection

Total TCP/IP Connection(s)

1

Source Host Address	Connection Type
192.168.19.201	Web/HTTP

Firmware Update

Load new or updated firmware onto the ioLogik from the Firmware Update page.

Firmware Update

Choose a new firmware file path :

D:\FWR_E1211_V1.1_Build09081410_STD.1kp

WARNING:

1. The firmware update process may take a few minutes.
2. NOTE! Once you click the "Update" button, the update process cannot be canceled.
3. DO NOT DISCONNECT POWER OR NETWORK CABLE during the update process, since doing so could cause the firmware to become corrupted.

Import System Config

Import a configuration into the ioLogik server from the Import System Config page. This function can be used to duplicate settings between ioLogik servers. You will be prompted for the location of the configuration file (i.e., "ik1212.txt").

Import System Configuration File

Update network settings (IP, DNS, Gateway, etc.)

Choose a system configuration file path :

C:\ik1212.txt

WARNING:

1. The file import process could take up to 10 seconds.
2. DO NOT DISCONNECT POWER OR NETWORK CABLE during the upload process, since doing so could cause the system to become corrupted.

Export System Config

On the Export System Config page, you can save the ioLogik's configuration into a file for backup or import into another ioLogik server.

Export System Settings

Click "[ik1212.txt](#)" to export & save system settings.

Peer-to-peer Settings

Peer-to-peer Settings (1-50)

The ioLogik E1200 supports up to 50 peer-to-peer mapping rules. You can configure the channel settings 10 at a time. To enable the rules, either select the **Enable All** box to enable all 10 channels, or select the **Enable** box individually for each rule. The **Local Channel** drop-down menu allows you to specify the channel of the ioLogik E1200 to configure. Type the IP address and port number of a remote ioLogik E1200 in the **Remote IP** and **Remote Ports** fields, respectively. The **Remote Channel** field is for you to select input channels of the remote ioLogik E1200 when you select output channels in the **Local Channel** field. Set the **Interval Time** and **On change** percentage on the local ioLogik E1200 that will trigger the transmission of a mapping signal to the remote ioLogik E1200. The default local listen port number is 9020; this value can be set between 1 to 65535.

NOTE If you select a DI or AI channel in the Local Channel field, the Remote Channel field will be disabled. You need to configure the DO or AO channel on the remote ioLogik E1200.

Peer to Peer Settings

Enable All

Peer to Peer Select Setting Table

Enable	No.	Local Channel	Remote IP	Remote Port	Remote Channel	Interval Time (500-65535 ms)	On Change	Direction
<input checked="" type="checkbox"/>	1	DI_00	192.168.127.253	9020		<input checked="" type="checkbox"/> 500 ms	<input type="checkbox"/> 1 %	DI -> DO (Peer to)
<input checked="" type="checkbox"/>	2	DI_01	192.168.127.253	9020		<input checked="" type="checkbox"/> 500 ms	<input type="checkbox"/> 1 %	DI -> DO (Peer to)
<input checked="" type="checkbox"/>	3	DI_02	192.168.127.253	9020		<input checked="" type="checkbox"/> 500 ms	<input type="checkbox"/> 1 %	DI -> DO (Peer to)
<input checked="" type="checkbox"/>	4	DI_03	192.168.127.253	9020		<input checked="" type="checkbox"/> 500 ms	<input type="checkbox"/> 1 %	DI -> DO (Peer to)
<input checked="" type="checkbox"/>	5	DI_04	192.168.127.253	9020		<input checked="" type="checkbox"/> 500 ms	<input type="checkbox"/> 1 %	DI -> DO (Peer to)
<input checked="" type="checkbox"/>	6	DI_05	192.168.127.253	9020		<input checked="" type="checkbox"/> 500 ms	<input type="checkbox"/> 1 %	DI -> DO (Peer to)
<input checked="" type="checkbox"/>	7	DI_06	0.0.0.0	9020		<input checked="" type="checkbox"/> 500 ms	<input type="checkbox"/> 1 %	DI -> DO (Peer to)
<input checked="" type="checkbox"/>	8	DI_07	0.0.0.0	9020		<input checked="" type="checkbox"/> 500 ms	<input type="checkbox"/> 1 %	DI -> DO (Peer to)
<input checked="" type="checkbox"/>	9	DO_00	0.0.0.0	9020		<input checked="" type="checkbox"/> 500 ms	<input type="checkbox"/> 1 %	DI -> DO (Peer to)
<input checked="" type="checkbox"/>	10	DO_01	0.0.0.0	9020		<input checked="" type="checkbox"/> 500 ms	<input type="checkbox"/> 1 %	DI -> DO (Peer to)
<input checked="" type="checkbox"/>	11	DO_02	0.0.0.0	9020		<input checked="" type="checkbox"/> 500 ms	<input type="checkbox"/> 1 %	DI -> DO (Peer to)
<input checked="" type="checkbox"/>	12	DO_03	0.0.0.0	9020		<input checked="" type="checkbox"/> 500 ms	<input type="checkbox"/> 1 %	DI -> DO (Peer to)
<input checked="" type="checkbox"/>	13	AI_00	0.0.0.0	9020		<input checked="" type="checkbox"/> 500 ms	<input type="checkbox"/> 1 %	DI -> DO (Peer to)
<input checked="" type="checkbox"/>	14	AI_01	0.0.0.0	9020		<input checked="" type="checkbox"/> 500 ms	<input type="checkbox"/> 1 %	DI -> DO (Peer to)
<input checked="" type="checkbox"/>	15	AI_02	0.0.0.0	9020		<input checked="" type="checkbox"/> 500 ms	<input type="checkbox"/> 1 %	DI -> DO (Peer to)
<input checked="" type="checkbox"/>	16	AI_03	0.0.0.0	9020		<input checked="" type="checkbox"/> 500 ms	<input type="checkbox"/> 1 %	DI -> DO (Peer to)
<input checked="" type="checkbox"/>	17	DI_00	0.0.0.0	9020		<input checked="" type="checkbox"/> 500 ms	<input type="checkbox"/> 1 %	DI -> DO (Peer to)

Local Listen Port (1-65535, Default:9020)

Sample Configuration

The following is an example of configuring DO (Server IP: 192.168.127.253) to DI (Client IP: 192.168.127.252) peer-to-peer functionality with two ioLogik E1200 devices.

Server settings:

Peer to Peer Select Setting Table

Enable	No.	Local Channel	Remote IP	Remote Port	Remote Channel	Interval Time (500-65535 ms)	On Change	Direction
<input checked="" type="checkbox"/>	1	DO_00	192.168.127.252	9020	DI_00	<input type="checkbox"/> 0 ms	<input type="checkbox"/> 1 %	DO <- DI (Peer From)

Client settings:

Peer to Peer Select Setting Table								
Enable	No.	Local Channel	Remote IP	Remote Port	Remote Channel	Interval Time (500-65535 ms)	On Change	Direction
<input checked="" type="checkbox"/>	1	DI_00	192.168.127.253	9020		<input checked="" type="checkbox"/> 500 ms	<input type="checkbox"/> 1 %	DI -> DO (Peer to)

Note: refer to the table below for maximum number of rules supported at different signal frequencies.

	1 Hz	2 Hz	4 Hz	10 Hz	20 Hz
1 rule	✓	✓	✓	✓	✓
10 rules	✓	✓	✓		
20 rules	✓	✓	✓		
30 rules	✓	✓			
40 rules	✓	✓			
50 rules	✓				

DO Safe Mode Settings

When a peer-to-peer rule on a local DO channel is not valid, the local DO channel will enter safe mode. You can set the DO to be Hold Last, ON, or OFF in safe mode.

Peer-to-Peer DO Channels Safe Mode Settings

Enable	DO Channel	Mode	Safe Mode Status
<input type="checkbox"/>	DO-00	DO	OFF
<input type="checkbox"/>	DO-01	DO	OFF
<input type="checkbox"/>	DO-02	DO	OFF
<input type="checkbox"/>	DO-03	DO	OFF

AO Safe Mode Settings

When a peer-to-peer rule of the local AO channel is not valid, the local AO channel will enter safe mode. You can either set the AO safe value from 0-4095 or enable Hold Last Status during Safe Mode.

Peer-to-Peer AO Channels Safe Mode Settings

Enable	AO Channel	Mode	Safe Mode Value
<input checked="" type="checkbox"/>	AO-00	0-10V	1000 (0-4095) <input type="checkbox"/> Hold Last Status
<input checked="" type="checkbox"/>	AO-01	0-10V	0 (0-4095) <input checked="" type="checkbox"/> Hold Last Status
<input checked="" type="checkbox"/>	AO-02	0-10V	3000 (0-4095) <input type="checkbox"/> Hold Last Status
<input checked="" type="checkbox"/>	AO-03	0-10V	0 (0-4095) <input checked="" type="checkbox"/> Hold Last Status

Change Password

For all changes to the ioLogik E1200's password protection settings, you will first need to enter the old password. Leave this blank if you are setting up password protection for the first time. To set up a new password or change the existing password, enter your desired password under both **New password** and **Confirm password**. To remove password protection, leave the **New password** and **Confirm password** fields blank.

Change Password

Password

Old password :

New password :

Retype password :



ATTENTION

If you forget the password, the **ONLY** way to configure the ioLogik E1200 is by using the reset button to load the factory defaults.

Before you set a password for the first time, it is a good idea to export the configuration to a file when you have finished setting up your ioLogik E1200. Your configuration can then be easily imported back into the ioLogik E1200 if you need to reset the ioLogik E1200 due to a forgotten password or for other reasons.

Load Factory Default

This function will reset all of the ioLogik E1200's settings to the factory default values. All previous settings, including the console password will be lost.

Load Factory Default

This function will reset the I/O Server settings to their factory default values. Current settings will be overwritten.

Save/Restart

If you change the configuration, do not forget to reboot the system.

Save/Restart

The configuration has been changed. Click Submit to reboot with the new configuration.

WARNING: Rebooting will disconnect your Ethernet connections and some data loss may occur.

Using ioSearch

This chapter describes ioSearch, which is used to search for and locate ioLogik E1200 units.

The following topics are covered in this chapter:

▣ **Introduction to ioSearch**

▣ **ioSearch Main Screen**

- Main Screen Overview

▣ **Main Items**

- System
- Sort
- Quick Links

▣ **Main Function**

- Locate
- Firmware Upgrade
- Unlock
- Import
- Export
- Change IP Address
- Restart System
- Reset to Default

Introduction to ioSearch

ioSearch is for locating or searching for an Logik E1200 on the physical network. The following functions are supported by the ioSearch utility.

- Search for and locate ioLogik E1200 units.
- IP address configuration.
- Firmware upgrade for multiple ioLogik E1200 units (same model).
- Export configuration files from multiple ioLogik E1200 units.
- Import a configuration file to multiple ioLogik E1200 units (same model).
- Reset to default for multiple ioLogik E1200 units.

ioSearch Main Screen

Main Screen Overview

The main screen displays the result of the broadcast search of the ioLogik E1200.

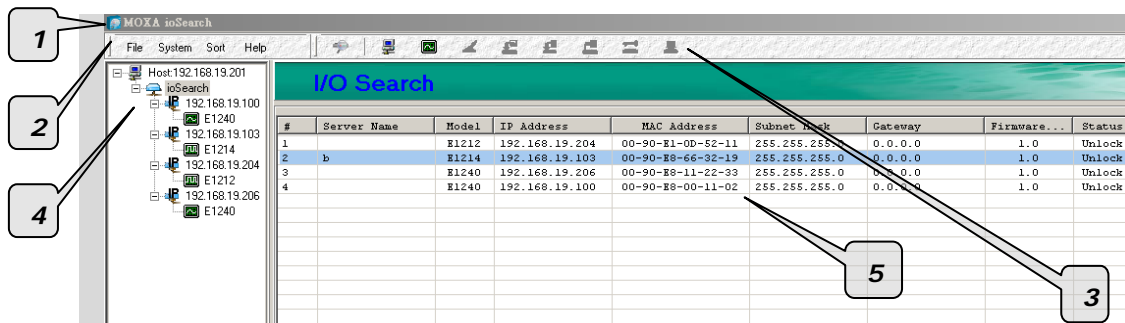

ioSearch Main Screen	
1.	Title
2.	Menu bar
3.	Quick link
4.	Navigation panel
5.	Main window

Main Items

System

Several operations are possible from the **System** menu.

Auto Scan Active Ethernet I/O Servers will search for ioLogik servers on the network. When connecting for the first time or recovering from a network disconnection, you can use this command to find I/O servers that are on the network.

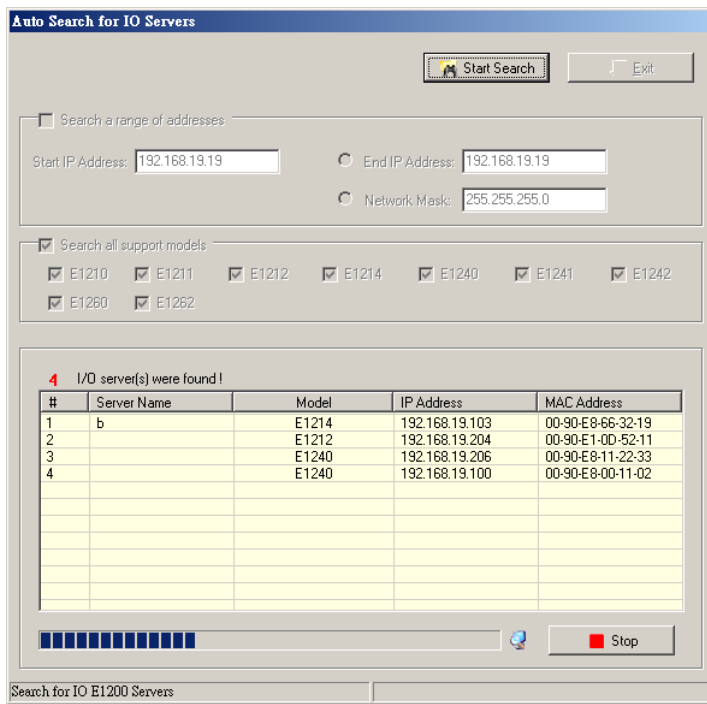

Network Interface allows you to select a network to use, if the PC has multiple network adaptors installed.

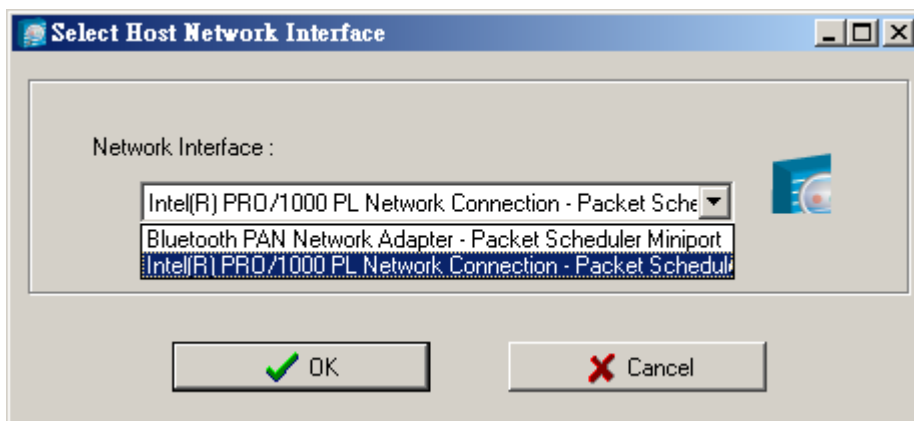

Sort

The **Sort** menu allows the server list in the navigation panel to be sorted by ioLogik connection and server (model).

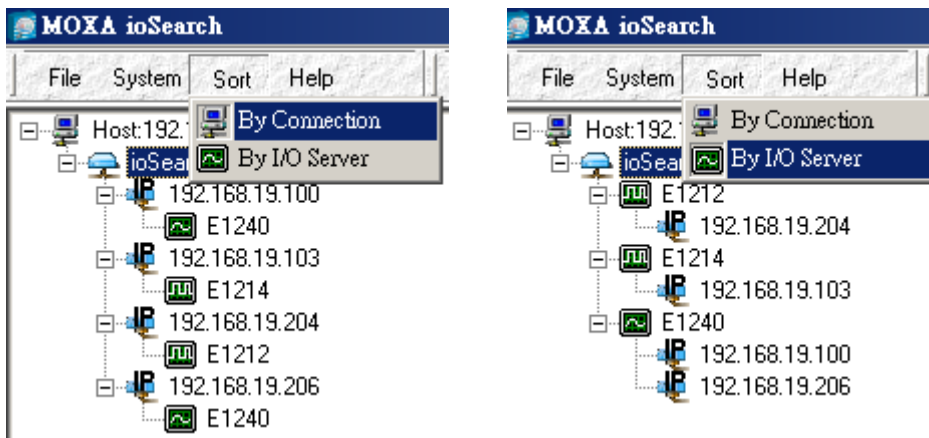

Quick Links

Quick links are provided to search for I/O servers on the network and sort the server list.



1	Automatically search the local network
2	Sort by ioLogik E1200's IP address (connection)
3	Sort by ioLogik E1200 model
4	Locate an ioLogik E1200
5	Upgrade Firmware
6	Import settings
7	Export settings
8	Unlock an ioLogik E1200 which is password protected
9	Change IP Address of an ioLogik E1200

Main Function

Right click on a particular ioLogik E1200 to view the ioSearch function menu.

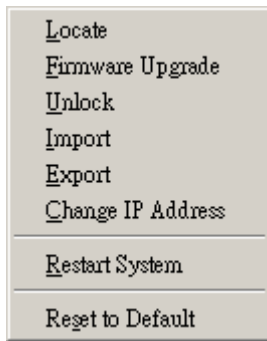

Locate

The locate function helps users find a dedicated ioLogik on the network. When this function is triggered, the ready LED on the selected unit will start to blink indicating its location.

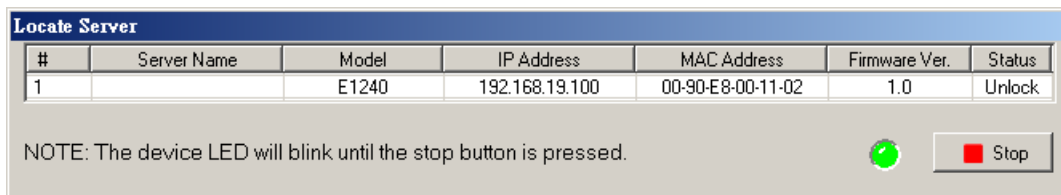

Firmware Upgrade

The ioLogik E1200 supports a remote firmware upgrade function. Enter the path to the firmware file or click on the icon to browse for the file. The wizard will lead you through the process until the server is restarted.

Multiple firmware upgrades are allowed for same ioLogik model. Press the "Shift" key, select the ioLogik, and right click to process multiple firmware upgrades.

#	Server Name	Model	IP Address	MAC Address	Subnet Mask	Gateway	Firmware...	Status
1		E1212	192.168.19.204	00-90-E1-0D-52-11	255.255.255.0	0.0.0.0	1.0	Lock
2	b	E1214	192.168.19.103	00-90-E8-66-32-19	255.255.255.0	0.0.0.0	1.0	Unlock
3		E1240	192.168.19.206	00-90-E8-11-22-33	255.255.255.0	0.0.0.0	1.0	Unlock
4		E1240	192.168.19.100	00-90-E8-00-11-02	255.255.255.0	0.0.0.0	1.0	Unlock

- Locate
- Firmware Upgrade
- Unlock
- Import
- Export
- Change IP Address
- Restart System
- Reset to Default



ATTENTION

Do not interrupt the firmware update process! An interruption in the process may result in your device becoming unrecoverable.

Unlock

If an ioLogik E1200 is password protected, unlock the ioLogik E1200 by entering the password before using any of the functions.

Unlock Server							
#	Server Name	Model	IP Address	MAC Address	Firmware Ver.	Status	Unlock
1		E1212	192.168.19.204	00-90-E1-0D-52-11	1.0	Lock	

Enter Password: (8 char max.)

Import

Select this command to reload a configuration that was exported to a text file.

Importing one configuration file to multiple ioLogik E1200 units (same model) is allowed. To do this, press the "Shift" key, select the ioLogik, and then right click.

#	Server Name	Model	IP Address	MAC Address	Subnet Mask	Gateway	Firmware...	Status
1		E1212	192.168.19.204	00-90-E1-0D-52-11	255.255.255.0	0.0.0.0	1.0	Lock
2	b	E1214	192.168.19.103	00-90-E8-66-32-19	255.255.255.0	0.0.0.0	1.0	Unlock
3		E1240	192.168.19.206	00-90-E8-11-22-33	255.255.255.0	0.0.0.0	1.0	Unlock
4		E1240	192.168.19.100	00-90-E8-00-11-02	255.255.255.0	0.0.0.0	1.0	Unlock

- Locate
- Firmware Upgrade
- Unlock
- Import
- Export
- Change IP Address
- Restart System
- Reset to Default

Export

The export function is used to export the current configuration file of an ioLogik E1200. The export file format will be **ik12xx.txt** where "xx" represents the model type of the ioLogik E1200.

Exporting multiple files for different models of ioLogik E1200 is allowed. The file format is **ik12xx_MAC Address.txt**, where the xx represents the model types of the ioLogik E1200.

e.g., ik1214_00-90-E8-66-32-19.txt

To export multiple configuration files, select the ioLogik and right click to process this function.

#	Server Name	Model	IP Address	MAC Address	Subnet Mask	Gateway	Firmware...	Status
1		E1212	192.168.19.204	00-90-E1-0D-52-11	255.255.255.0	0.0.0.0	1.0	Lock
2	b	E1214	192.168.19.103	00-90-E8-66-32-19	255.255.255.0	0.0.0.0	1.0	Unlock
3		E1240	192.168.19.206	00-90-E8-11-22-33	255.255.255.0	0.0.0.0	1.0	Unlock
4		E1240	192.168.19.100		255.255.255.0	0.0.0.0	1.0	Unlock

- Locate
- Firmware Upgrade
- Unlock
- Import
- Export**
- Change IP Address
- Restart System
- Reset to Default

Change IP Address

The Change IP Address function can be used to directly modify the IP Address, especially for first time installation.

Changing the IP address for multiple ioLogik E1200's is allowed. Select the ioLogik E1200 and then right click to process this function.

#	Server Name	Model	IP Address	MAC Address	Subnet Mask	Gateway	Firmware...	Status
1		E1212	192.168.19.204	00-90-E1-0D-52-11	255.255.255.0	0.0.0.0	1.0	Lock
2	b	E1214	192.168.19.103	00-90-E8-66-32-19	255.255.255.0	0.0.0.0	1.0	Unlock
3		E1240	192.168.19.206		255.255.255.0	0.0.0.0	1.0	Unlock
4		E1240	192.168.19.100		255.255.255.0	0.0.0.0	1.0	Unlock

- Locate
- Firmware Upgrade
- Unlock
- Import
- Export
- Change IP Address**
- Restart System
- Reset to Default

Change IP Address							
#	Server Name	Model	IP Address	MAC Address	Firmware Ver.	Status	Change IP
1	b	E1214	192.168.19.103	00-90-E8-66-32-19	1.0	Unlock	
2		E1240	192.168.19.206	00-90-E8-11-22-33	1.0	Unlock	Set

Restart System

Select this command to restart the selected ioLogik E1200.

Restarting multiple ioLogik E1200 units is allowed. Select the ioLogik E1200 and right click to process this function.

#	Server Name	Model	IP Address	MAC Address	Subnet Mask	Gateway	Firmware...	Status
1		E1212	192.168.19.204	00-90-E1-0D-52-11	255.255.255.0	0.0.0.0	1.0	Lock
2	b	E1214	192.168.19.103	00-90-E8-66-32-19	255.255.255.0	0.0.0.0	1.0	Unlock
3		E1240	192.168.19.206	00-90-E8-11-22-33	255.255.255.0	0.0.0.0	1.0	Unlock
4		E1240	192.168.19.100	00-90-E8-11-22-33	255.255.255.0	0.0.0.0	1.0	Unlock

- Locate
- Firmware Upgrade
- Unlock
- Import
- Export
- Change IP Address
- Restart System**
- Reset to Default

Restart Server

#	Server Name	Model	IP Address	MAC Address	Firmware Ver.	Status	Restart
1	b	E1214	192.168.19.103	00-90-E8-66-32-19	1.0	Unlock	Success
2		E1240	192.168.19.206	00-90-E8-11-22-33	1.0	Unlock	

Restarting I/O Server

Wait for IO server to restart. 3

Stop
Exit

Reset to Default

Select this function to reset all settings, including console password, to factory default values.

Resetting multiple ioLogik E1200 units to the default configuration is allowed. Select the ioLogik E1200 and right click to process this function.

#	Server Name	Model	IP Address	MAC Address	Subnet Mask	Gateway	Firmware...	Status
1		E1212	192.168.19.204	00-90-E1-0D-52-11	255.255.255.0	0.0.0.0	1.0	Lock
2	b	E1214	192.168.19.103	00-90-E8-66-32-19	255.255.255.0	0.0.0.0	1.0	Unlock
3		E1240	192.168.19.206	00-90-E8-11-22-33	255.255.255.0	0.0.0.0	1.0	Unlock
4		E1240	192.168.19.100	00-90-E8-11-22-33	255.255.255.0	0.0.0.0	1.0	Unlock

- Locate
- Firmware Upgrade
- Unlock
- Import
- Export
- Change IP Address
- Restart System
- Reset to Default**

Active OPC Server Lite

This chapter explains how to use the web console of the ioLogik E1200 to connect to the Active OPC Server Lite package.

The following topics are covered in this chapter:

❑ **Introduction to Active OPC Server Lite**

❑ **Active OPC Server Lite Specifications**

- Installing Active OPC Server Lite
- Installing OPC Core Components

❑ **Active OPC Server Lite**

- Main Screen Overview

❑ **Menu Items**

- File
- System
- Sort
- Quick Links

❑ **Tag Generation**

❑ **Heartbeat Interval**

- Read/Write Privilege

❑ **OPC Test Client**

Introduction to Active OPC Server Lite

Moxa's Active OPC Server Lite is a software package operated as an OPC driver of an HMI or SCADA system. It offers a seamless connection from Moxa's ioLogik series products to SCADA systems, including Wonderware, Citect, and iFix. Active OPC Server Lite meets the latest standard of OPC DA3.0 that allows connections to various kinds of devices and host OPC machines.

Active OPC Server Lite Specifications

Hardware Requirements	
CPU	Intel Pentium (Pentium 4 and above)
RAM	512 MB (1024 MB recommended)
Network Interface	10/100 Mb Ethernet
Software Requirements	
Operating System	Microsoft Windows 2000, XP or later
Editor (Not necessary)	Microsoft Office 2003 (Access 2003) or later
OPC Server Specifications	
OPC Data Access	1.0a, 2.0, 2.05a, 3.0
Max. tags	1,200 (V1.7 or later)

Installing Active OPC Server Lite

Active OPC Server Lite can be found in the **Document and Software CD**, or downloaded from the Moxa Website. The following steps show how to install Active OPC Server Lite from the CD.

1. **Installing from CD:** Insert the Document and Software CD into the host computer. In the Software\AOPCLite\ActiveOPCSets directory of the CD, locate and run Install.exe. The installation program will guide you through the installation process and install the Active OPC Server Lite utility.
2. **Open Active OPC Server Lite:** After installation is finished, run Active OPC Server Lite from the Windows Start menu: **Start Program Files MOXA IO Server ActiveOPC→ActiveOPC.**

Installing OPC Core Components

OPC Core Components provides the connection library needed by Active OPC Server Lite. This package must be installed on the Active OPC Server Lite computer.

For first time installation, a pop-up message will appear asking if you would like to install the OPC Core Components. You may skip this step if the package has already been installed.

Active OPC Server Lite

Main Screen Overview

Active OPC Server Lite's main screen displays a figure of the mapped ioLogik with the status of every I/O tag. Note that configuration and tags are not available until the ioLogik creates the tags.

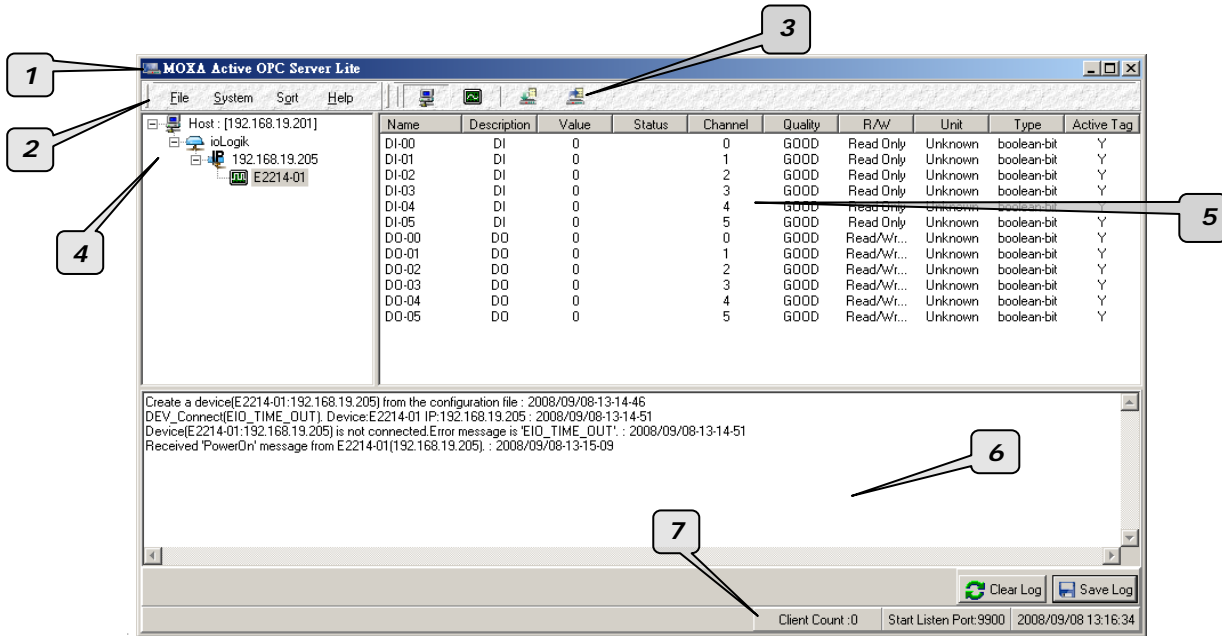

Active OPC Server Lite Main Screen
1. Title
2. Menu bar
3. Quick link
4. Navigation panel
5. Tag Window
6. Log Monitor
7. Status bar

Menu Items

File

From the **File** menu, you can export the list ioLogik units that are currently displayed in the navigation panel. You also can import a list into Active OPC Server Lite.

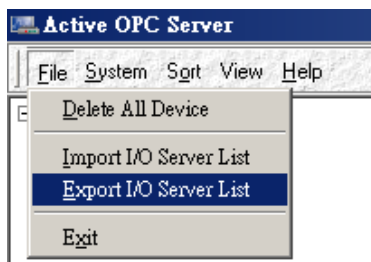

The file will have the **.mdb** extension, and can be opened using Microsoft Office Access. The server list includes the current tag information of the mapped ioLogik. We recommend saving the configuration when exiting the Active OPC Server.

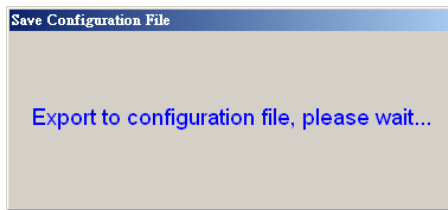

System

Several operations can be accessed from the **System** menu.

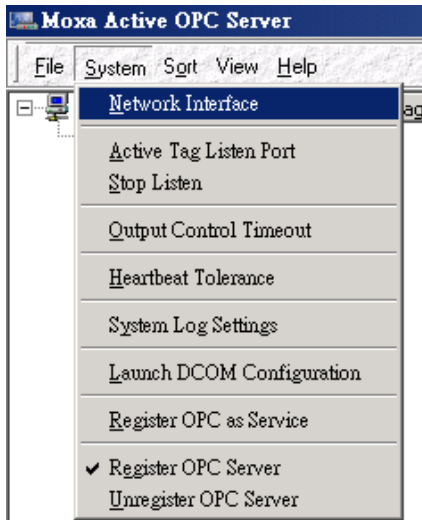

Network Interface allows users to select a network interface on this Active OPC Server which will accept connections from the remote ioAdmin utility.

Active Tag Listen Port allows users to select the preferred TCP socket port for tag generation from ioAdmin.

Stop Listen allows users to stop receiving tag generation messages and I/O status updates.

Output Control Timeout allows users to define the timeout interval of a controlling output channel on a remote ioLogik.

Register OPC Server is used to register the DCOM components to the Windows system. After Active OPC Server Lite is installed, it will automatically configure the DCOM.

Heartbeat Tolerance allows users to define the timeout to wait for a heartbeat signal from a remote ioLogik.

System Log Settings allows users to enable or disable Active OPC Server system log function.

Launch DCOM Configuration allows users to launch the Windows DCOM configuration utility.

Register OPC as Service allows users to make the Active OPC Server program run as a Windows system service.

Unregister OPC Server is used to cancel the registration of the DCOM components from the Windows system.

Sort



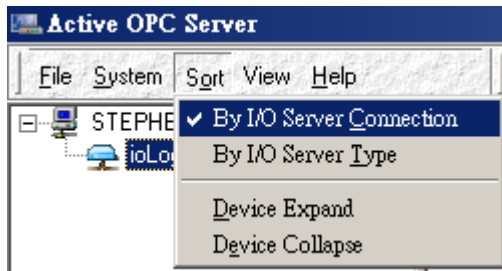

The **Sort** menu allows the server list in the navigation panel to be sorted by connection and type (model).



Quick Links

Quick links are provided to sort the server list and import/export configuration.



	Sort by connection
	Sort by server type
	Import configuration
	Export configuration

Tag Generation

Tag configuration of an ioLogik E1200 is specified by its web console. Open the browser and go to the **Active OPC Server Settings** page.

Follow these steps to create the tag from the ioLogik E1200 to Active OPC Server Lite:

In the AOPC & I/O Settings page,

Check the "Enable Active OPC" box and specify the IP address where the Active OPC Server Lite is installed.

Select the I/O channels that need to be created in the Active OPC Server Lite.

Configure the Heartbeat Interval, if necessary.

- Main Menu - E1240

- Overview
- Network Settings
- User-defined Modbus Addressing
- Active OPC Server Settings
 - AOPC & I/O Settings**
 - Create AOPC Tag
- I/O Settings
- System Management
- Change Password
- Load Factory Default
- Save/Restart

Active OPC Server Settings

Enable Active OPC

No.	IP Address	Port
1	<input type="text" value="192.168.19.205"/>	<input type="text" value="9900"/>
2	<input type="text" value="0.0.0.0"/>	<input type="text" value="9900"/>

I/O Channel Settings

Enable All DI Channels

Ch00 Ch01 Ch02 Ch03 Ch04 Ch05 Ch06 Ch07

On Change: %

Active OPC Server HeartBeat Settings

Heartbeat Interval: sec (1-65535, Default = 60)

Click the "Submit" button and click the Save/Restart button on the next page.

Configuration Complete!

Warning! The changes will take effect until you Save/Restart the I/O Server.

You can Save / Restart the I/O Server now or Save / Restart the I/O Server when all settings complete.



On the Create AOPC Tag page, click on the **Create Tags** button to push the tag configuration to Active OPC Server Lite.

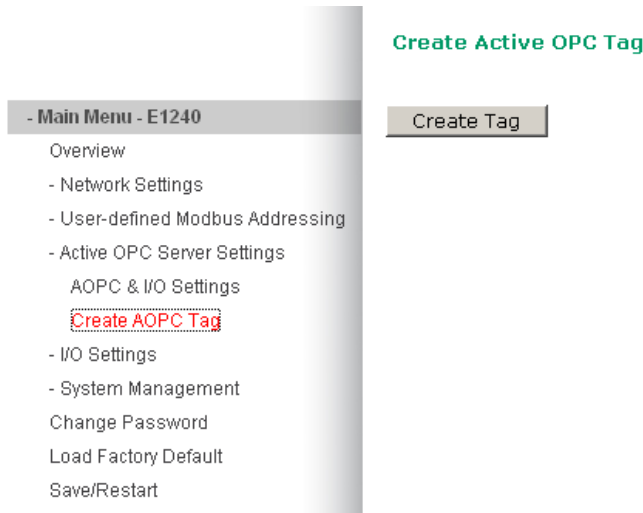

Launch the Active OPC Server Lite program; tags will be automatically created.

Save the configuration of the Active OPC Server Lite when exiting the program.

Heartbeat Interval

Tags are event-driven and updated only when the status of an I/O channel changes. When the status remains unchanged, the Active OPC Server Lite will not receive updates. To ensure that the ioLogik is connected and alive, **Heartbeat Interval** can be used to determine the connection status between the ioLogik and Active OPC Server Lite. If the heartbeat interval is set and the network between the ioLogik and Active OPC Server Lite is down, Active OPC Server Lite will detect the stop of the heartbeat and the Quality column will show **BAD** to indicate the loss of the connection. The maximum interval is 65,535 seconds.

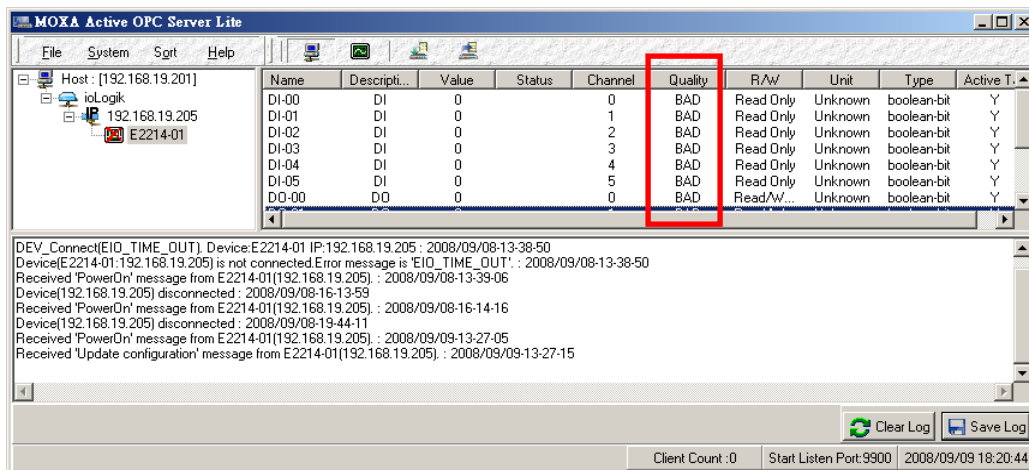

Read/Write Privilege

An input channel can only be read while an output channel shows "read/write acceptable" on the Active OPC Server Lite.

OPC Test Client

An OPC client software is embedded in the Active OPC Server Lite package for test purposes. After configuring the tags on the Active OPC Server Lite, this **ClientTest** can be launched from the Windows Start menu: **Start → Program Files → MOXA → IO Server → ActiveOPC → ClientTest**.

If Active OPC Server Lite is installed locally on the same PC, select **Connect → Local** from the menu bar. Specify the **MOXA ACTIVE OPC SERVER** in the **Server Name** column.

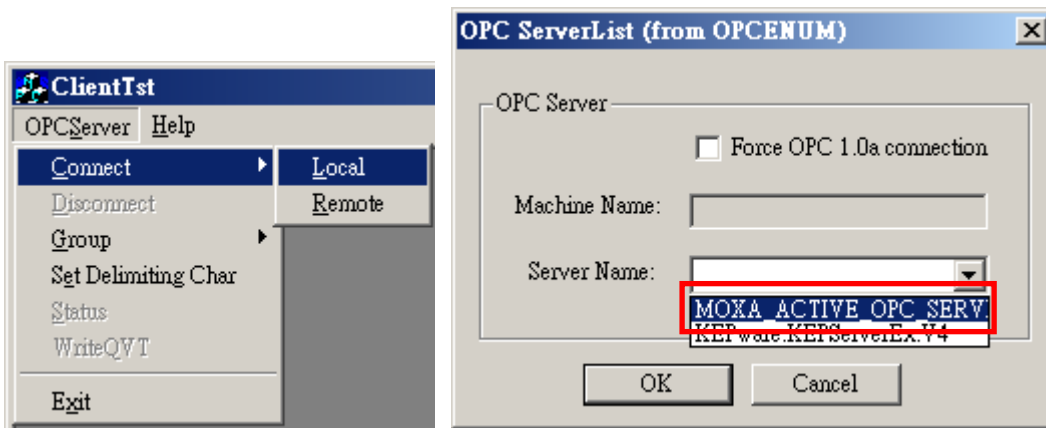

If the Active OPC Server Lite is installed on a remote PC, select **Connect → Remote** from the menu bar. Input the host name (i.e. Moxa_Client) or IP address and specify **MOXA ACTIVE OPC SERVER** in the **Server Name** column.

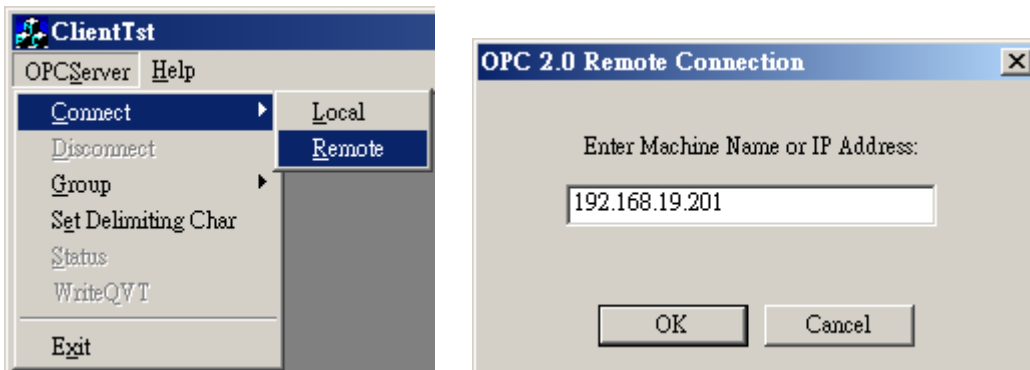

Click on **Group → Add** and specify the **Group Name** (user-defined). A blank tag monitoring screen will open.

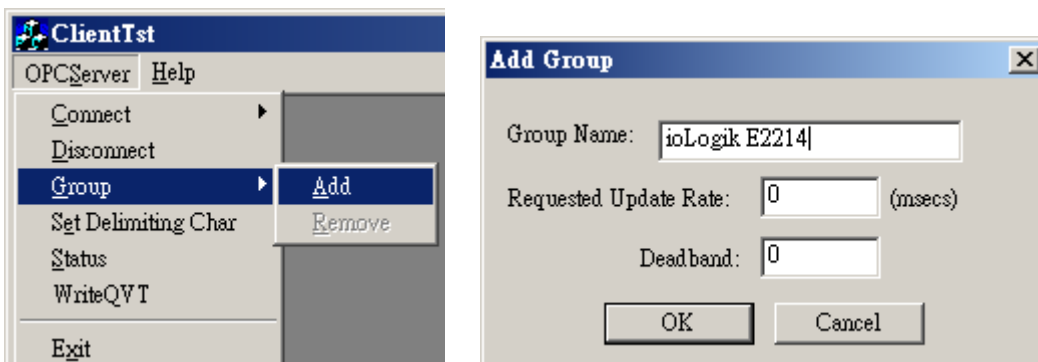



Click **Item** → **Browse** and select the channel that needs to be monitored.

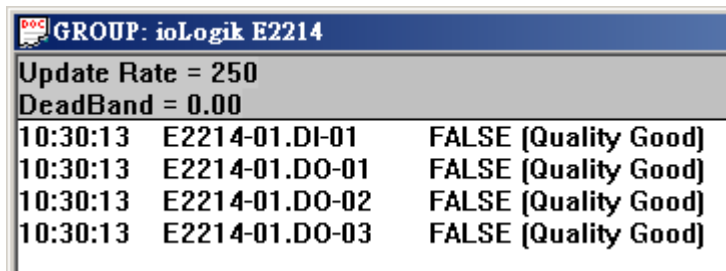
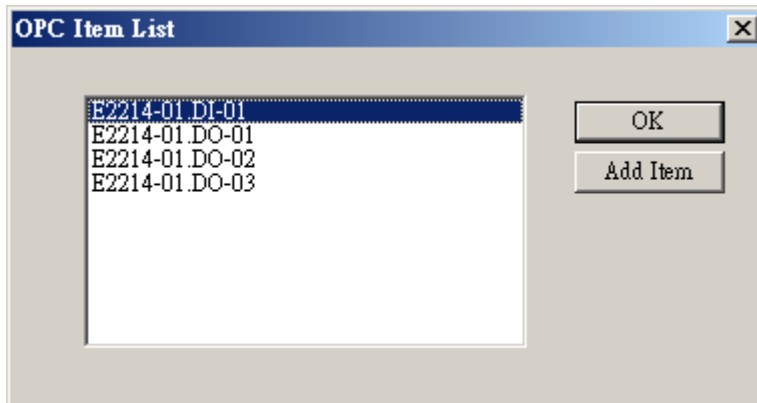
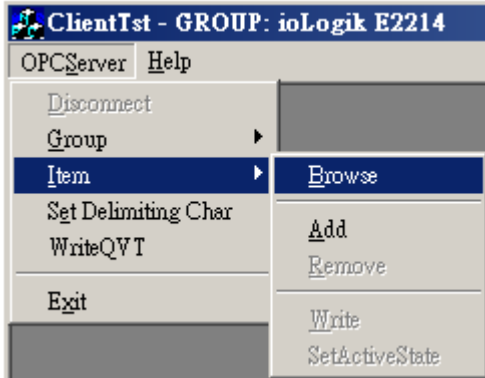

To write to the output channel, specify an output channel, and then select **Item** → **Write** from the menu bar.

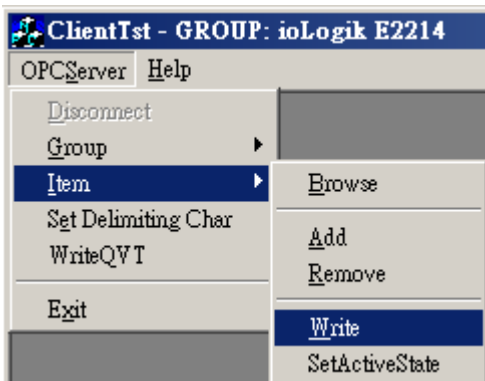

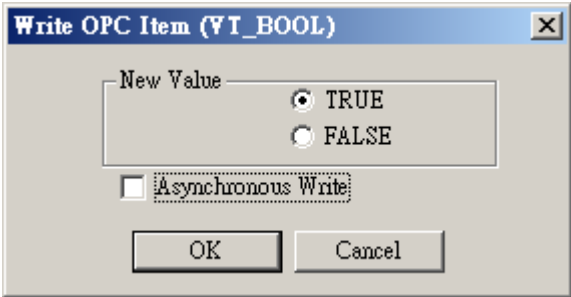

A

Modbus/TCP Default Address Mappings

The following topics are covered in this appendix:

- E1210 Modbus Mapping**
- E1211 Modbus Mapping**
- E1212 Modbus Mapping**
- E1214 Modbus Mapping**
- E1240 Modbus Mapping**
- E1241 Modbus Mapping**
- E1242 Modbus Mapping**
- E1260 Modbus Mapping**
- E1262 Modbus Mapping**

NOTE The Modbus/TCP ID of the ioLogik E1200 is set to "1" by default.

E1210 Modbus Mapping

0xxxx Read/Write Coils (Functions 1, 5, 15)

Reference	Address	Data Type	Description
00257	0x0100	1 bit	CH0 DI Counter Operate Status 0: Stop 1: Start(R/W)
00258	0x0101	1 bit	CH1 DI Counter Operate Status 0: Stop 1: Start(R/W)
00259	0x0102	1 bit	CH2 DI Counter Operate Status 0: Stop 1: Start(R/W)
00260	0x0103	1 bit	CH3 DI Counter Operate Status 0: Stop 1: Start(R/W)
00261	0x0104	1 bit	CH4 DI Counter Operate Status 0: Stop 1: Start(R/W)
00262	0x0105	1 bit	CH5 DI Counter Operate Status 0: Stop 1: Start(R/W)
00263	0x0106	1 bit	CH6 DI Counter Operate Status 0: Stop 1: Start(R/W)
00264	0x0107	1 bit	CH7 DI Counter Operate Status 0: Stop 1: Start(R/W)
00265	0x0108	1 bit	CH8 DI Counter Operate Status 0: Stop 1: Start(R/W)
00266	0x0109	1 bit	CH9 DI Counter Operate Status 0: Stop 1: Start(R/W)
00267	0x010A	1 bit	CH10 DI Counter Operate Status 0: Stop 1: Start(R/W)
00268	0x010B	1 bit	CH11 DI Counter Operate Status 0: Stop 1: Start(R/W)
00269	0x010C	1 bit	CH12 DI Counter Operate Status 0: Stop 1: Start(R/W)
00270	0x010D	1 bit	CH13 DI Counter Operate Status 0: Stop 1: Start(R/W)
00271	0x010E	1 bit	CH14 DI Counter Operate Status 0: Stop 1: Start(R/W)
00272	0x010F	1 bit	CH15 DI Counter Operate Status 0: Stop 1: Start(R/W)
00273	0x0110	1 bit	CH0 DI Clear Count Value Read A lways return:0 Write: 1 : Clear counter value 0 : Return illegal data value(0x03)
00274	0x0111	1 bit	CH1 DI Clear Count Value Read A lways return:0 Write: 1 : Clear counter value 0 : Return illegal data value(0x03)
00275	0x0112	1 bit	CH2 DI Clear Count Value Read A lways return:0 Write: 1 : Clear counter value 0 : Return illegal data value(0x03)
00276	0x0113	1 bit	CH3 DI Clear Count Value Read A lways return:0 Write: 1 : Clear counter value 0 : Return illegal data value(0x03)
00277	0x0114	1 bit	CH4 DI Clear Count Value Read A lways return:0 Write: 1 : Clear counter value 0 : Return illegal data value(0x03)
00278	0x0115	1 bit	CH5 DI Clear Count Value Read A lways return:0 Write: 1 : Clear counter value 0 : Return illegal data value(0x03)
00279	0x0116	1 bit	CH6 DI Clear Count Value Read A lways return:0 Write: 1 : Clear counter value

			0 : Return illegal data value(0x03)
00280	0x0117	1 bit	CH7 DI Clear Count Value Read Always return:0 Write: 1 : Clear counter value 0 : Return illegal data value(0x03)
00281	0x0118	1 bit	CH8 DI Clear Count Value Read Always return:0 Write: 1 : Clear counter value 0 : Return illegal data value(0x03)
00282	0x0119	1 bit	CH9 DI Clear Count Value Read Always return:0 Write: 1 : Clear counter value 0 : Return illegal data value(0x03)
00283	0x011A	1 bit	CH10 DI Clear Count Value Read Always return:0 Write: 1 : Clear counter value 0 : Return illegal data value(0x03)
00284	0x011B	1 bit	CH11 DI Clear Count Value Read Always return:0 Write: 1 : Clear counter value 0 : Return illegal data value(0x03)
00285	0x011C	1 bit	CH12 DI Clear Count Value Read Always return:0 Write: 1 : Clear counter value 0 : Return illegal data value(0x03)
00286	0x011D	1 bit	CH13 DI Clear Count Value Read Always return:0 Write: 1 : Clear counter value 0 : Return illegal data value(0x03)
00287	0x011E	1 bit	CH14 DI Clear Count Value Read Always return:0 Write: 1 : Clear counter value 0 : Return illegal data value(0x03)
00288	0x011F	1 bit	CH15 DI Clear Count Value Read Always return:0 Write: 1 : Clear counter value 0 : Return illegal data value(0x03)

1xxxx Read Only Coils (Function 2)

Reference	Address	Data Type	Description
10001	0x0000	1 bit	CH0 DI Value , 0=OFF , 1=ON (Read only)
10002	0x0001	1 bit	CH1 DI Value , 0=OFF , 1=ON (Read only)
10003	0x0002	1 bit	CH2 DI Value , 0=OFF , 1=ON (Read only)
10004	0x0003	1 bit	CH3 DI Value , 0=OFF , 1=ON (Read only)
10005	0x0004	1 bit	CH4 DI Value , 0=OFF , 1=ON (Read only)
10006	0x0005	1 bit	CH5 DI Value , 0=OFF , 1=ON (Read only)
10007	0x0006	1 bit	CH6 DI Value , 0=OFF , 1=ON (Read only)
10008	0x0007	1 bit	CH7 DI Value , 0=OFF , 1=ON (Read only)
10009	0x0008	1 bit	CH8 DI Value , 0=OFF , 1=ON (Read only)
10010	0x0009	1 bit	CH9 DI Value , 0=OFF , 1=ON (Read only)
10011	0x000A	1 bit	CH10 DI Value , 0=OFF , 1=ON (Read only)
10012	0x000B	1 bit	CH11 DI Value , 0=OFF , 1=ON (Read only)

10013	0x000C	1 bit	CH12 DI Value · 0=OFF · 1=ON (Read only)
10014	0x000D	1 bit	CH13 DI Value · 0=OFF · 1=ON (Read only)
10015	0x000E	1 bit	CH14 DI Value · 0=OFF · 1=ON (Read only)
10016	0x000F	1 bit	CH15 DI Value · 0=OFF · 1=ON (Read only)

3xxxx Read Only Registers (Function 4)

Reference	Address	Data Type	Description
30017	0x0010	1 word	CH0 DI Counter Value Hi- Word (Read only)
30018	0x0011	1 word	CH0 DI Counter Value Lo- Word (Read only)
30019	0x0012	1 word	CH1 DI Counter Value Hi- Word (Read only)
30020	0x0013	1 word	CH1 DI Counter Value Lo- Word (Read only)
30021	0x0014	1 word	CH2 DI Counter Value Hi- Word (Read only)
30022	0x0015	1 word	CH2 DI Counter Value Lo- Word (Read only)
30023	0x0016	1 word	CH3 DI Counter Value Hi- Word (Read only)
30024	0x0017	1 word	CH3 DI Counter Value Lo- Word (Read only)
30025	0x0018	1 word	CH4 DI Counter Value Hi- Word (Read only)
30026	0x0019	1 word	CH4 DI Counter Value Lo- Word (Read only)
30027	0x001A	1 word	CH5 DI Counter Value Hi- Word (Read only)
30028	0x001B	1 word	CH5 DI Counter Value Lo- Word (Read only)
30029	0x001C	1 word	CH6 DI Counter Value Hi- Word (Read only)
30030	0x001D	1 word	CH6 DI Counter Value Lo- Word (Read only)
30031	0x001E	1 word	CH7 DI Counter Value Hi- Word (Read only)
30032	0x001F	1 word	CH7 DI Counter Value Lo- Word (Read only)
30033	0x0020	1 word	CH8 DI Counter Value Hi- Word (Read only)
30034	0x0021	1 word	CH8 DI Counter Value Lo- Word (Read only)
30035	0x0022	1 word	CH9 DI Counter Value Hi- Word (Read only)
30036	0x0023	1 word	CH9 DI Counter Value Lo- Word (Read only)
30037	0x0024	1 word	CH10 DI Counter Value Hi- Word (Read only)
30038	0x0025	1 word	CH10 DI Counter Value Lo- Word (Read only)
30039	0x0026	1 word	CH11 DI Counter Value Hi- Word (Read only)
30040	0x0027	1 word	CH11 DI Counter Value Lo- Word (Read only)
30041	0x0028	1 word	CH12 DI Counter Value Hi- Word (Read only)
30042	0x0029	1 word	CH12 DI Counter Value Lo- Word (Read only)
30043	0x002A	1 word	CH13 DI Counter Value Hi- Word (Read only)
30044	0x002B	1 word	CH13 DI Counter Value Lo- Word (Read only)
30045	0x002C	1 word	CH14 DI Counter Value Hi- Word (Read only)
30046	0x002D	1 word	CH14 DI Counter Value Lo- Word (Read only)
30047	0x002E	1 word	CH15 DI Counter Value Hi- Word (Read only)
30048	0x002F	1 word	CH15 DI Counter Value Lo- Word (Read only)
30049	0x0030	1 word	DI Value (Ch0~15) Bit0 = Ch0 DI Value (0=OFF, 1=ON) Bit15 = Ch15 DI Value (0=OFF, 1=ON)

E1211 Modbus Mapping

0xxxx Read/Write Coils (Functions 1, 5, 15)

Reference	Address	Data Type	Description
00001	0x0000	1 bit	CH0 DO Value 0 : Off 1 : On

00002	0x0001	1 bit	CH1 DO Value 0 : Off 1 : On
00003	0x0002	1 bit	CH2 DO Value 0 : Off 1 : On
00004	0x0003	1 bit	CH3 DO Value 0 : Off 1 : On
00005	0x0004	1 bit	CH4 DO Value 0 : Off 1 : On
00006	0x0005	1 bit	CH5 DO Value 0 : Off 1 : On
00007	0x0006	1 bit	CH6 DO Value 0 : Off 1 : On
00008	0x0007	1 bit	CH7 DO Value 0 : Off 1 : On
00009	0x0008	1 bit	CH8 DO Value 0 : Off 1 : On
00010	0x0009	1 bit	CH9 DO Value 0 : Off 1 : On
00011	0x000A	1 bit	CH10 DO Value 0 : Off 1 : On
00012	0x000B	1 bit	CH11 DO Value 0 : Off 1 : On
00013	0x000C	1 bit	CH12 DO Value 0 : Off 1 : On
00014	0x000D	1 bit	CH13 DO Value 0 : Off 1 : On
00015	0x000E	1 bit	CH14 DO Value 0 : Off 1 : On
00016	0x000F	1 bit	CH15 DO Value 0 : Off 1 : On
00017	0x0010	1 bit	CH0 DO Pulse Operate Status 0 : Off 1 : On
00018	0x0011	1 bit	CH1 DO Pulse Operate Status 0 : Off 1 : On
00019	0x0012	1 bit	CH2 DO Pulse Operate Status 0 : Off 1 : On
00020	0x0013	1 bit	CH3 DO Pulse Operate Status 0 : Off 1 : On
00021	0x0014	1 bit	CH4 DO Pulse Operate Status 0 : Off 1 : On
00022	0x0015	1 bit	CH5 DO Pulse Operate Status 0 : Off 1 : On
00023	0x0016	1 bit	CH6 DO Pulse Operate Status 0 : Off 1 : On
00024	0x0017	1 bit	CH7 DO Pulse Operate Status 0 : Off 1 : On
00025	0x0018	1 bit	CH8 DO Pulse Operate Status 0 : Off 1 : On
00026	0x0019	1 bit	CH9 DO Pulse Operate Status 0 : Off 1 : On
00027	0x001A	1 bit	CH10 DO Pulse Operate Status 0 : Off 1 : On
00028	0x001B	1 bit	CH11 DO Pulse Operate Status 0 : Off 1 : On
00029	0x001C	1 bit	CH12 DO Pulse Operate Status 0 : Off 1 : On
00030	0x001D	1 bit	CH13 DO Pulse Operate Status 0 : Off 1 : On
00031	0x001E	1 bit	CH14 DO Pulse Operate Status 0 : Off 1 : On
00032	0x001F	1 bit	CH15 DO Pulse Operate Status 0 : Off 1 : On

E1212 Modbus Mapping

0xxxx Read/Write Coils (Functions 1, 5, 15)

Reference	Address	Data Type	Description
DO Channel			
00001	0x0000	1 bit	CH0 DO Value 0 : Off 1 : On
00002	0x0001	1 bit	CH1 DO Value 0 : Off 1 : On
00003	0x0002	1 bit	CH2 DO Value 0 : Off 1 : On
00004	0x0003	1 bit	CH3 DO Value 0 : Off 1 : On
00005	0x0004	1 bit	CH4 DO Value 0 : Off 1 : On
00006	0x0005	1 bit	CH5 DO Value 0 : Off 1 : On
00007	0x0006	1 bit	CH6 DO Value 0 : Off 1 : On
00008	0x0007	1 bit	CH7 DO Value 0 : Off 1 : On
00017	0x0010	1 bit	CH0 DO Pulse Operate Status 0 : Off 1 : On
00018	0x0011	1 bit	CH1 DO Pulse Operate Status 0 : Off 1 : On
00019	0x0012	1 bit	CH2 DO Pulse Operate Status 0 : Off 1 : On
00020	0x0013	1 bit	CH3 DO Pulse Operate Status 0 : Off 1 : On
00021	0x0014	1 bit	CH4 DO Pulse Operate Status 0 : Off 1 : On

00022	0x0015	1 bit	CH5 DO Pulse Operate Status 0: Off 1: On
00023	0x0016	1 bit	CH6 DO Pulse Operate Status 0: Off 1: On
00024	0x0017	1 bit	CH7 DO Pulse Operate Status 0: Off 1: On
DI Channel			
00257	0x0100	1 bit	CH0 DI Counter Operate Status 0: Stop 1: Start(R/W)
00258	0x0101	1 bit	CH1 DI Counter Operate Status 0: Stop 1: Start(R/W)
00259	0x0102	1 bit	CH2 DI Counter Operate Status 0: Stop 1: Start(R/W)
00260	0x0103	1 bit	CH3 DI Counter Operate Status 0: Stop 1: Start(R/W)
00261	0x0104	1 bit	CH4 DI Counter Operate Status 0: Stop 1: Start(R/W)
00262	0x0105	1 bit	CH5 DI Counter Operate Status 0: Stop 1: Start(R/W)
00263	0x0106	1 bit	CH6 DI Counter Operate Status 0: Stop 1: Start(R/W)
00264	0x0107	1 bit	CH7 DI Counter Operate Status 0: Stop 1: Start(R/W)
00265	0x0108	1 bit	CH8 DI Counter Operate Status 0: Stop 1: Start(R/W)
00266	0x0109	1 bit	CH9 DI Counter Operate Status 0: Stop 1: Start(R/W)
00267	0x010A	1 bit	CH10 DI Counter Operate Status 0: Stop 1: Start(R/W)
00268	0x010B	1 bit	CH11 DI Counter Operate Status 0: Stop 1: Start(R/W)
00269	0x010C	1 bit	CH12 DI Counter Operate Status 0: Stop 1: Start(R/W)
00270	0x010D	1 bit	CH13 DI Counter Operate Status 0: Stop 1: Start(R/W)
00271	0x010E	1 bit	CH14 DI Counter Operate Status 0: Stop 1: Start(R/W)
00272	0x010F	1 bit	CH15 DI Counter Operate Status 0: Stop 1: Start(R/W)
00273	0x0110	1 bit	CH0 DI Clear Count Value Read A lways return:0 Write: 1 : Clear counter value 0 : Return illegal data value(0x03)
00274	0x0111	1 bit	CH1 DI Clear Count Value Read A lways return:0 Write: 1 : Clear counter value 0 : Return illegal data value(0x03)
00275	0x0112	1 bit	CH2 DI Clear Count Value Read A lways return:0 Write: 1 : Clear counter value 0 : Return illegal data value(0x03)
00276	0x0113	1 bit	CH3 DI Clear Count Value Read A lways return:0 Write: 1 : Clear counter value 0 : Return illegal data value(0x03)
00277	0x0114	1 bit	CH4 DI Clear Count Value Read A lways return:0 Write: 1 : Clear counter value 0 : Return illegal data value(0x03)
00278	0x0115	1 bit	CH5 DI Clear Count Value Read A lways return:0 Write: 1 : Clear counter value 0 : Return illegal data value(0x03)
00279	0x0116	1 bit	CH6 DI Clear Count Value Read A lways return:0 Write: 1 : Clear counter value 0 : Return illegal data value(0x03)
00280	0x0117	1 bit	CH7 DI Clear Count Value Read A lways return:0 Write: 1 : Clear counter value 0 : Return illegal data value(0x03)
00281	0x0118	1 bit	CH8 DI Clear Count Value Read A lways return:0

			Write: 1 : Clear counter value 0 : Return illegal data value(0x03)
00282	0x0119	1 bit	CH9 DI Clear Count Value Read Always return:0 Write: 1 : Clear counter value 0 : Return illegal data value(0x03)
00283	0x011A	1 bit	CH10 DI Clear Count Value Read Always return:0 Write: 1 : Clear counter value 0 : Return illegal data value(0x03)
00284	0x011B	1 bit	CH11 DI Clear Count Value Read Always return:0 Write: 1 : Clear counter value 0 : Return illegal data value(0x03)
00285	0x011C	1 bit	CH12 DI Clear Count Value Read Always return:0 Write: 1 : Clear counter value 0 : Return illegal data value(0x03)
00286	0x011D	1 bit	CH13 DI Clear Count Value Read Always return:0 Write: 1 : Clear counter value 0 : Return illegal data value(0x03)
00287	0x011E	1 bit	CH14 DI Clear Count Value Read Always return:0 Write: 1 : Clear counter value 0 : Return illegal data value(0x03)
00288	0x011F	1 bit	CH15 DI Clear Count Value Read Always return:0 Write: 1 : Clear counter value 0 : Return illegal data value(0x03)

1xxxx Read Only Coils (Function 2)

Reference	Address	Data Type	Description
10001	0x0000	1 bit	CH0 DI Value , 0=OFF , 1=ON (Read only)
10002	0x0001	1 bit	CH1 DI Value , 0=OFF , 1=ON (Read only)
10003	0x0002	1 bit	CH2 DI Value , 0=OFF , 1=ON (Read only)
10004	0x0003	1 bit	CH3 DI Value , 0=OFF , 1=ON (Read only)
10005	0x0004	1 bit	CH4 DI Value , 0=OFF , 1=ON (Read only)
10006	0x0005	1 bit	CH5 DI Value , 0=OFF , 1=ON (Read only)
10007	0x0006	1 bit	CH6 DI Value , 0=OFF , 1=ON (Read only)
10008	0x0007	1 bit	CH7 DI Value , 0=OFF , 1=ON (Read only)
10009	0x0008	1 bit	CH8 DI Value , 0=OFF , 1=ON (Read only)
10010	0x0009	1 bit	CH9 DI Value , 0=OFF , 1=ON (Read only)
10011	0x000A	1 bit	CH10 DI Value , 0=OFF , 1=ON (Read only)
10012	0x000B	1 bit	CH11 DI Value , 0=OFF , 1=ON (Read only)
10013	0x000C	1 bit	CH12 DI Value , 0=OFF , 1=ON (Read only)
10014	0x000D	1 bit	CH13 DI Value , 0=OFF , 1=ON (Read only)
10015	0x000E	1 bit	CH14 DI Value , 0=OFF , 1=ON (Read only)
10016	0x000F	1 bit	CH15 DI Value , 0=OFF , 1=ON (Read only)

3xxxx Read Only Registers (Function 4)

Reference	Address	Data Type	Description
30018	0x0011	1 word	CH0 DI Counter Value Lo- Word (Read only)
30019	0x0012	1 word	CH1 DI Counter Value Hi- Word (Read only)
30020	0x0013	1 word	CH1 DI Counter Value Lo- Word (Read only)
30021	0x0014	1 word	CH2 DI Counter Value Hi- Word (Read only)
30022	0x0015	1 word	CH2 DI Counter Value Lo- Word (Read only)
30023	0x0016	1 word	CH3 DI Counter Value Hi- Word (Read only)
30024	0x0017	1 word	CH3 DI Counter Value Lo- Word (Read only)
30025	0x0018	1 word	CH4 DI Counter Value Hi- Word (Read only)
30026	0x0019	1 word	CH4 DI Counter Value Lo- Word (Read only)
30027	0x001A	1 word	CH5 DI Counter Value Hi- Word (Read only)
30028	0x001B	1 word	CH5 DI Counter Value Lo- Word (Read only)
30029	0x001C	1 word	CH6 DI Counter Value Hi- Word (Read only)
30030	0x001D	1 word	CH6 DI Counter Value Lo- Word (Read only)
30031	0x001E	1 word	CH7 DI Counter Value Hi- Word (Read only)
30032	0x001F	1 word	CH7 DI Counter Value Lo- Word (Read only)
30033	0x0020	1 word	CH8 DI Counter Value Hi- Word (Read only)
30034	0x0021	1 word	CH8 DI Counter Value Lo- Word (Read only)
30035	0x0022	1 word	CH9 DI Counter Value Hi- Word (Read only)
30036	0x0023	1 word	CH9 DI Counter Value Lo- Word (Read only)
30037	0x0024	1 word	CH10 DI Counter Value Hi- Word (Read only)
30038	0x0025	1 word	CH10 DI Counter Value Lo- Word (Read only)
30039	0x0026	1 word	CH11 DI Counter Value Hi- Word (Read only)
30040	0x0027	1 word	CH11 DI Counter Value Lo- Word (Read only)
30041	0x0028	1 word	CH12 DI Counter Value Hi- Word (Read only)
30042	0x0029	1 word	CH12 DI Counter Value Lo- Word (Read only)
30043	0x002A	1 word	CH13 DI Counter Value Hi- Word (Read only)
30044	0x002B	1 word	CH13 DI Counter Value Lo- Word (Read only)
30045	0x002C	1 word	CH14 DI Counter Value Hi- Word (Read only)
30046	0x002D	1 word	CH14 DI Counter Value Lo- Word (Read only)
30047	0x002E	1 word	CH15 DI Counter Value Hi- Word (Read only)
30048	0x002F	1 word	CH15 DI Counter Value Lo- Word (Read only)
30049	0x0030	1 word	DI Value (Ch0~15) Bit0 = Ch0 DI Value (0=OFF, 1=ON) Bit15 = Ch15 DI Value (0=OFF, 1=ON)

4xxxx Read/Write Registers (Functions 3, 6, 16)

Reference	Address	Data Type	Description
DO Channel			
40033	0x0020	1 word	DO all Value (Ch0~15) Bit0 = Ch0 DO Value (0=OFF, 1=ON) Bit15 = Ch15 DO Value (0=OFF, 1=ON)

E1214 Modbus Mapping

0xxxx Read/Write Coils (Functions 1, 5, 15)

Reference	Address	Data Type	Description
DO Channel			
00001	0x0000	1 bit	CH0 DO Value 0 : Off 1 : On
00002	0x0001	1 bit	CH1 DO Value 0 : Off 1 : On
00003	0x0002	1 bit	CH2 DO Value 0 : Off 1 : On
00004	0x0003	1 bit	CH3 DO Value 0 : Off 1 : On
00005	0x0004	1 bit	CH4 DO Value 0 : Off 1 : On
00006	0x0005	1 bit	CH5 DO Value 0 : Off 1 : On
00017	0x0010	1 bit	CH0 DO Pulse Operate Status 0: Off 1: On
00018	0x0011	1 bit	CH1 DO Pulse Operate Status 0: Off 1: On
00019	0x0012	1 bit	CH2 DO Pulse Operate Status 0: Off 1: On
00020	0x0013	1 bit	CH3 DO Pulse Operate Status 0: Off 1: On
00021	0x0014	1 bit	CH4 DO Pulse Operate Status 0: Off 1: On
00022	0x0015	1 bit	CH5 DO Pulse Operate Status 0: Off 1: On
DI Channel			
00257	0x0100	1 bit	CH0 DI Counter Operate Status 0: Stop 1: Start(R/W)
00258	0x0101	1 bit	CH1 DI Counter Operate Status 0: Stop 1: Start(R/W)
00259	0x0102	1 bit	CH2 DI Counter Operate Status 0: Stop 1: Start(R/W)
00260	0x0103	1 bit	CH3 DI Counter Operate Status 0: Stop 1: Start(R/W)
00261	0x0104	1 bit	CH4 DI Counter Operate Status 0: Stop 1: Start(R/W)
00262	0x0105	1 bit	CH5 DI Counter Operate Status 0: Stop 1: Start(R/W)
00273	0x0110	1 bit	CH0 DI Clear Count Value Read A lways return:0 Write: 1 : Clear counter value 0 : Return illegal data value(0x03)
00274	0x0111	1 bit	CH1 DI Clear Count Value Read A lways return:0 Write: 1 : Clear counter value 0 : Return illegal data value(0x03)
00275	0x0112	1 bit	CH2 DI Clear Count Value Read A lways return:0 Write: 1 : Clear counter value 0 : Return illegal data value(0x03)
00276	0x0113	1 bit	CH3 DI Clear Count Value Read A lways return:0 Write: 1 : Clear counter value 0 : Return illegal data value(0x03)
00277	0x0114	1 bit	CH4 DI Clear Count Value Read A lways return:0 Write: 1 : Clear counter value 0 : Return illegal data value(0x03)
00278	0x0115	1 bit	CH5 DI Clear Count Value Read A lways return:0 Write: 1 : Clear counter value 0 : Return illegal data value(0x03)

1xxxx Read Only Coils (Function 2)

Reference	Address	Data Type	Description
10001	0x0000	1 bit	CH0 DI Value , 0=OFF , 1=ON (Read only)
10002	0x0001	1 bit	CH1 DI Value , 0=OFF , 1=ON (Read only)
10003	0x0002	1 bit	CH2 DI Value , 0=OFF , 1=ON (Read only)
10004	0x0003	1 bit	CH3 DI Value , 0=OFF , 1=ON (Read only)
10005	0x0004	1 bit	CH4 DI Value , 0=OFF , 1=ON (Read only)
10006	0x0005	1 bit	CH5 DI Value , 0=OFF , 1=ON (Read only)

3xxxx Read Only Registers (Function 4)

Reference	Address	Data Type	Description
30001	0x0000	2 word	CH0 Read AO Scaling Value (float)
30002	0x0001	2 word	CH1 Read AO Scaling Value (float)
30003	0x0002	2 word	CH2 Read AO Scaling Value (float)
30004	0x0003	2 word	CH3 Read AO Scaling Value (float)
30017	0x0010	1 word	CH0 DI Counter Value Hi- Word (Read only)
30018	0x0011	1 word	CH0 DI Counter Value Lo- Word (Read only)
30019	0x0012	1 word	CH1 DI Counter Value Hi- Word (Read only)
30020	0x0013	1 word	CH1 DI Counter Value Lo- Word (Read only)
30021	0x0014	1 word	CH2 DI Counter Value Hi- Word (Read only)
30022	0x0015	1 word	CH2 DI Counter Value Lo- Word (Read only)
30023	0x0016	1 word	CH3 DI Counter Value Hi- Word (Read only)
30024	0x0017	1 word	CH3 DI Counter Value Lo- Word (Read only)
30025	0x0018	1 word	CH4 DI Counter Value Hi- Word (Read only)
30026	0x0019	1 word	CH4 DI Counter Value Lo- Word (Read only)
30027	0x001A	1 word	CH5 DI Counter Value Hi- Word (Read only)
30028	0x001B	1 word	CH5 DI Counter Value Lo- Word (Read only)
30049	0x0030	1 word	DI Value (Ch0~5) Bit0 = Ch0 DI Value (0=OFF, 1=ON) Bit5 = Ch5 DI Value (0=OFF, 1=ON)

4xxxx Read/Write Registers (Functions 3, 6, 16)

Reference	Address	Data Type	Description
41025	0x0400	1 word	CH0 AO RAW Value
41026	0x0401	1 word	CH1 AO RAW Value
41027	0x0402	1 word	CH2 AO RAW Value
41028	0x0403	1 word	CH3 AO RAW Value
40033	0x0020	1 word	DO all Value (Ch0~5) Bit0 = Ch0 DO Value (0=OFF, 1=ON) Bit5 = Ch5 DO Value (0=OFF, 1=ON)

E1240 Modbus Mapping

3xxxx Read Only Registers (Function 4)

Reference	Address	Data Type	Description
30001	0x0000	1 word	CH0 Read AI Value
30002	0x0001	1 word	CH1 Read AI Value
30003	0x0002	1 word	CH2 Read AI Value
30004	0x0003	1 word	CH3 Read AI Value
30005	0x0004	1 word	CH4 Read AI Value
30006	0x0005	1 word	CH5 Read AI Value
30007	0x0006	1 word	CH6 Read AI Value
30008	0x0007	1 word	CH7 Read AI Value
30009	0x0008	1 word	CH0 Read AI Scaling Value Hi (float)
30010	0x0009	1 word	CH0 Read AI Scaling Value Low (float)
30011	0x000A	1 word	CH1 Read AI Scaling Value Hi (float)
30012	0x000B	1 word	CH1 Read AI Scaling Value Low (float)
30013	0x000C	1 word	CH2 Read AI Scaling Value Hi (float)
30014	0x000D	1 word	CH2 Read AI Scaling Value Low (float)
30015	0x000E	1 word	CH3 Read AI Scaling Value Hi (float)
30016	0x000F	1 word	CH3 Read AI Scaling Value Low (float)
30017	0x0010	1 word	CH4 Read AI Scaling Value Hi (float)
30018	0x0011	1 word	CH4 Read AI Scaling Value Low (float)
30019	0x0012	1 word	CH5 Read AI Scaling Value Hi (float)
30020	0x0013	1 word	CH5 Read AI Scaling Value Low (float)
30021	0x0014	1 word	CH6 Read AI Scaling Value Hi (float)
30022	0x0015	1 word	CH6 Read AI Scaling Value Low (float)
30023	0x0016	1 word	CH7 Read AI Scaling Value Hi (float)
30024	0x0017	1 word	CH7 Read AI Scaling Value Low (float)

E1241 Modbus Mapping

3xxxx Read Only Registers (Function 4)

Reference	Address	Data Type	Description
30001	0x0000	2 word	CH0 Read AO Scaling Value (float)
30002	0x0001	2 word	CH1 Read AO Scaling Value (float)
30003	0x0002	2 word	CH2 Read AO Scaling Value (float)
30004	0x0003	2 word	CH3 Read AO Scaling Value (float)

4xxxx Read/Write Registers (Functions 3, 6, 16)

Reference	Address	Data Type	Description
41025	0x0400	1 word	CH0 AO RAW Value
41026	0x0401	1 word	CH1 AO RAW Value
41027	0x0402	1 word	CH2 AO RAW Value
41028	0x0403	1 word	CH3 AO RAW Value

E1242 Modbus Mapping

0xxxx Read/Write Coils (Functions 1, 5, 15)

Reference	Address	Data Type	Description
DO Channel			
00001	0x0000	1 bit	CH0 DO Value 0 : Off 1 : On
00002	0x0001	1 bit	CH1 DO Value 0 : Off 1 : On
00003	0x0002	1 bit	CH2 DO Value 0 : Off 1 : On
00004	0x0003	1 bit	CH3 DO Value 0 : Off 1 : On
00017	0x0010	1 bit	CH0 DO Pulse Operate Status 0: Off 1: On
00018	0x0011	1 bit	CH1 DO Pulse Operate Status 0: Off 1: On
00019	0x0012	1 bit	CH2 DO Pulse Operate Status 0: Off 1: On
00020	0x0013	1 bit	CH3 DO Pulse Operate Status 0: Off 1: On
DI Channel			
00257	0x0100	1 bit	CH0 DI Counter Operate Status 0: Stop 1: Start(R/W)
00258	0x0101	1 bit	CH1 DI Counter Operate Status 0: Stop 1: Start(R/W)
00259	0x0102	1 bit	CH2 DI Counter Operate Status 0: Stop 1: Start(R/W)
00260	0x0103	1 bit	CH3 DI Counter Operate Status 0: Stop 1: Start(R/W)
00261	0x0104	1 bit	CH4 DI Counter Operate Status 0: Stop 1: Start(R/W)
00262	0x0105	1 bit	CH5 DI Counter Operate Status 0: Stop 1: Start(R/W)
00263	0x0106	1 bit	CH6 DI Counter Operate Status 0: Stop 1: Start(R/W)
00264	0x0107	1 bit	CH7 DI Counter Operate Status 0: Stop 1: Start(R/W)
00273	0x0110	1 bit	CH0 DI Clear Count Value Read A lways return:0 Write: 1 : Clear counter value 0 : Return illegal data value(0x03)
00274	0x0111	1 bit	CH1 DI Clear Count Value Read A lways return:0 Write: 1 : Clear counter value 0 : Return illegal data value(0x03)
00275	0x0112	1 bit	CH2 DI Clear Count Value Read A lways return:0 Write: 1 : Clear counter value 0 : Return illegal data value(0x03)
00276	0x0113	1 bit	CH3 DI Clear Count Value Read A lways return:0 Write: 1 : Clear counter value 0 : Return illegal data value(0x03)
00276	0x0113	1 bit	CH4 DI Clear Count Value Read A lways return:0 Write: 1 : Clear counter value 0 : Return illegal data value(0x03)
00276	0x0113	1 bit	CH5 DI Clear Count Value Read A lways return:0 Write: 1 : Clear counter value 0 : Return illegal data value(0x03)
00276	0x0113	1 bit	CH6 DI Clear Count Value Read A lways return:0 Write: 1 : Clear counter value 0 : Return illegal data value(0x03)

00276	0x0113	1 bit	CH7 DI Clear Count Value Read Always return:0 Write: 1 : Clear counter value 0 : Return illegal data value(0x03)
-------	--------	-------	---

1xxxx Read Only Coils (Function 2)

Reference	Address	Data Type	Description
DI Channel			
10001	0x0000	1 bit	CH0 DI Value , 0=OFF , 1=ON (Read only)
10002	0x0001	1 bit	CH1 DI Value , 0=OFF , 1=ON (Read only)
10003	0x0002	1 bit	CH2 DI Value , 0=OFF , 1=ON (Read only)
10004	0x0003	1 bit	CH3 DI Value , 0=OFF , 1=ON (Read only)
10005	0x0004	1 bit	CH4 DI Value , 0=OFF , 1=ON (Read only)
10006	0x0005	1 bit	CH5 DI Value , 0=OFF , 1=ON (Read only)
10007	0x0006	1 bit	CH6 DI Value , 0=OFF , 1=ON (Read only)
10008	0x0007	1 bit	CH7 DI Value , 0=OFF , 1=ON (Read only)

3xxxx Read Only Registers (Function 4)

Reference	Address	Data Type	Description
DI Channel			
30017	0x0010	1 word	CH0 DI Counter Value Hi- Word (Read only)
30018	0x0011	1 word	CH0 DI Counter Value Lo- Word (Read only)
30019	0x0012	1 word	CH1 DI Counter Value Hi- Word (Read only)
30020	0x0013	1 word	CH1 DI Counter Value Lo- Word (Read only)
30021	0x0014	1 word	CH2 DI Counter Value Hi- Word (Read only)
30022	0x0015	1 word	CH2 DI Counter Value Lo- Word (Read only)
30023	0x0016	1 word	CH3 DI Counter Value Hi- Word (Read only)
30024	0x0017	1 word	CH3 DI Counter Value Lo- Word (Read only)
30025	0x0018	1 word	CH4 DI Counter Value Hi- Word (Read only)
30026	0x0019	1 word	CH4 DI Counter Value Lo- Word (Read only)
30027	0x001A	1 word	CH5 DI Counter Value Hi- Word (Read only)
30028	0x001B	1 word	CH5 DI Counter Value Lo- Word (Read only)
30029	0x001C	1 word	CH6 DI Counter Value Hi- Word (Read only)
30030	0x001D	1 word	CH6 DI Counter Value Lo- Word (Read only)
30031	0x001E	1 word	CH7 DI Counter Value Hi- Word (Read only)
30032	0x001F	1 word	CH7 DI Counter Value Lo- Word (Read only)
30049	0x0030	1 word	DI Value (Ch0~7) Bit0 = Ch0 DI Value (0=OFF, 1=ON) Bit7 = Ch7 DI Value (0=OFF, 1=ON) Bit8 to 15 = reserved
30513	0x0200	1 word	CH0 Read AI RAW Value
30514	0x0201	1 word	CH1 Read AI RAW Value
30515	0x0202	1 word	CH2 Read AI RAW Value
30516	0x0203	1 word	CH3 Read AI RAW Value
30521	0x0208	2 word	CH0 Read AI Scaling Value (float)
30522	0x0209	2 word	CH1 Read AI Scaling Value (float)
30523	0x020A	2 word	CH2 Read AI Scaling Value (float)
30524	0x020B	2 word	CH3 Read AI Scaling Value (float)

4xxxx Read/Write Registers (Functions 3, 6, 16)

Reference	Address	Data Type	Description
40033	0x0020	1 word	DO all Value (Ch0~3) Bit0 = Ch0 DO Value (0=OFF, 1=ON) Bit3 = Ch3 DO Value (0=OFF, 1=ON) Bit4 to 15 = reserved

E1260 Modbus Mapping

3xxxx Read Only Registers (Function 4)

Reference	Address	Data Type	Description
31537	0x0600	1 word	CH0 Read RTD Value Range 0~65535, Unit:0.1 (Ohm, Celsius, Fahrenheit)
31538	0x0601	1 word	CH1 Read RTD Value Range 0~65535, Unit:0.1 (Ohm, Celsius, Fahrenheit)
31539	0x0602	1 word	CH2 Read RTD Value Range 0~65535, Unit:0.1 (Ohm, Celsius, Fahrenheit)
31540	0x0603	1 word	CH3 Read RTD Value Range 0~65535, Unit:0.1 (Ohm, Celsius, Fahrenheit)
31541	0x0604	1 word	CH4 Read RTD Value Range 0~65535, Unit:0.1 (Ohm, Celsius, Fahrenheit)
31542	0x0605	1 word	CH5 Read RTD Value Range 0~65535, Unit:0.1 (Ohm, Celsius, Fahrenheit)

E1262 Modbus Mapping

3xxxx Read Only Registers (Function 4)

Reference	Address	Data Type	Description
32049	0x0800	1 word	CH0 TC Minimum Value Hi Word Unit:0.1 (Celsius, Fahrenheit) 0.0001(mV)
32050	0x0801	1 word	CH0 TC Minimum Value Lo Word Hi+Lo Range: 0~4294967295 Unit:0.1 (Celsius, Fahrenheit) 0.0001(mV)
32051	0x0802	1 word	CH1 TC Minimum Value Hi Word
32052	0x0803	1 word	CH1 TC Minimum Value Lo Word
32053	0x0804	1 word	CH2 TC Minimum Value Hi Word
32054	0x0805	1 word	CH2 TC Minimum Value Lo Word
32055	0x0806	1 word	CH3 TC Minimum Value Hi Word
32056	0x0807	1 word	CH3 TC Minimum Value Lo Word
32057	0x0808	1 word	CH4 TC Minimum Value Hi Word
32058	0x0809	1 word	CH4 TC Minimum Value Lo Word
32059	0x080A	1 word	CH5 TC Minimum Value Hi Word
32060	0x080B	1 word	CH5 TC Minimum Value Lo Word
32061	0x080C	1 word	CH6 TC Minimum Value Hi Word
32062	0x080D	1 word	CH6 TC Minimum Value Lo Word
32063	0x080E	1 word	CH7 TC Minimum Value Hi Word
32064	0x080F	1 word	CH7 TC Minimum Value Lo Word

32065	0x0810	1 word	CH8 TC Minimum Value Hi Word
32066	0x0811	1 word	CH8 TC Minimum Value Lo Word

B

Network Port Numbers

ioLogik E1200 Network Port Usage

Port	Type	Usage
80	TCP	Web console service
502	TCP	Modbus/TCP communication
68	UDP	BOOTP/DHCP
4800	UDP	Auto search
69	UDP	Export/import configuration file
9900	TCP	Active OPC Server Lite
9950	TCP	Active OPC Server Lite
9020 (default)	TCP	Peer-to-peer

Factory Defaults

ioLogik E1200 series products are configured with the following factory defaults:

Default IP address	192.168.127.254
Default Netmask	255.255.255.0
Default Gateway	0.0.0.0
Communication watchdog	Disable
Modbus/TCP Alive Check	On
Modbus/TCP Timeout Interval	60 sec
DI Mode	DI
Filter time	100 ms
Trigger for counter	Lo to Hi
Counter status	Stop
DO Mode	DO
DO Safe Status	Disable
Power on status	Disable
Low width for pulse	1 ms (1.5 s for relay)
Hi width for pulse	1 ms (1.5 s for relay)
Output pulses	0 (continuous)
DIO Mode	DO
AI Mode	Voltage
Scaling and Slop-Intercept	Disable
Password	N/A
Server Name	N/A
Server Location	N/A
AO Mode	Voltage
Scaling	Disable

D

Pinouts

Pin assignment of Terminal Blocks

ioLogik E1210 ioLogik E1211 ioLogik E1212 ioLogik E1214 ioLogik E1240
 (top to bottom) (top to bottom) (top to bottom) (top to bottom) (top to bottom)

1	COM 0	1		1	COM0	1	COM	1	AI0+
2	DI0	2	D00	2	DI0	2	DI0	2	AI0-
3	DI1	3	D01	3	DI1	3	DI1	3	AI1+
4	DI2	4	D02	4	DI2	4	DI2	4	AI1-
5	DI3	5	D03	5	DI3	5	DI3	5	AI2+
6	GND	6	GND	6	GND	6	DI4	6	AI2-
7	DI4	7	D04	7	DI4	7	DI5	7	AI3+
8	DI5	8	D05	8	DI5	8	GND	8	AI3-
9	DI6	9	D06	9	DI6	9	RO_NO	9	AI4+
10	DI7	10	D07	10	DI7	10	RO_C	10	AI4-
11	COM 1	11		11	COM1	11	R1_NO	11	AI5+
12	DI8	12	D08	12	DIO0	12	R1_C	12	AI5-
13	DI9	13	D09	13	DIO1	13	R2_NO	13	AI6+
14	DI10	14	D010	14	DIO2	14	R2_C	14	AI6-
15	DI11	15	D011	15	DIO3	15	R3_NO	15	AI7+
16	GND	16	GND	16	GND	16	R3_C	16	AI7-
17	DI12	17	D012	17	DIO4	17	R4_NO	17	
18	DI13	18	D013	18	DIO5	18	R4_C	18	
19	DI14	19	D014	19	DIO6	19	R5_NO	19	
20	DI15	20	D015	20	DIO7	20	R5_C	20	

ioLogik E1241 ioLogik E1242 ioLogik E1260 ioLogik E1262
 (top to bottom) (top to bottom) (top to bottom) (top to bottom)

1	V00+	1	AI0+	1	EX0	1	TC0+
2	V00-	2	AI0-	2	IN0+	2	TC0-
3	I00+	3	AI1+	3	IN0-	3	TC1+
4	I00-	4	AI1-	4	EX1	4	TC1-
5	V01+	5	AI2+	5	IN1+	5	TC2+
6	V01-	6	AI2-	6	IN1-	6	TC2-
7	I01+	7	AI3+	7	EX2	7	TC3+
8	I01-	8	AI3-	8	IN2+	8	TC3-
9	V02+	9	COM0	9	IN2-	9	TC4+
10	V02-	10	DI0	10	EX3	10	TC4-
11	I02+	11	DI1	11	IN3+	11	TC5+
12	I02-	12	DI2	12	IN3-	12	TC5-
13	V03+	13	DI3	13	EX4	13	TC6+
14	V03-	14	GND	14	IN4+	14	TC6-
15	I03+	15	COM1	15	IN4-	15	TC7+
16	I03-	16	DIO0	16	EX5	16	TC7-
17		17	DIO1	17	IN5+	17	
18		18	DIO2	18	IN5-	18	
19	EX_V	19	DIO3	19		19	
20	EX_C	20	GND	20		20	

FCC Interference Statement

Federal Communication Commission Warning!

This equipment has been tested and found to comply with the limits for a Class A digital device, pursuant to part 15 of the FCC Rules. Operation is subject to the following two conditions: (1) This device may not cause harmful interference, and (2) this device must accept any interference received, including interference that may cause undesired operation.

These limits are designed to provide reasonable protection against harmful interference when the equipment is operated in a commercial environment. This equipment generates, uses, and can radiate radio frequency energy and, if not installed and used in accordance with the instruction manual, may cause harmful interference to radio communications. Operation of this equipment in a residential area is likely to cause harmful interference in which case the user will be required to correct the interference at his own expense.

F

European Community (CE)

This is a Class A product. In a domestic environment, this product may cause radio interference in which case the user may be required to take adequate measures.